

Water-cooled chiller for indoor installation

ELFOEnergy Ground Medium²

WSH-XEE2 12.2-120.2 RANGE



TECHNICAL BULLETIN



SIZE	12.2	16.2	19.2	22.2	27.2	35.2	40.2	45.2	55.2	60.2	70.2	80.2	100.2	120.2
COOLING CAPACITY KW	35,6	49,8	59,3	68,4	84,2	109	124	147	173	197	222	250	305	356
HEATING CAPACITY KW	41,3	57,6	68,4	80,7	96,5	125	143	169	200	228	256	289	354	419

Page

System solutions	4
Standard unit technical specifications	5
Unit configuration	6
Built-in configuration options	8
Accessories separately supplied	9
General technical data	12
Electronic control	19
Natural cooling functions	20
Configurations	21
Performance	36
Dimensional drawings	42



Clivet is taking part in the EUROVENT certification programme up to 1.500 kW. The products concerned appear in the certified products list of the EUROVENT www.eurovent-certification.com site.

ELFOEnergy Ground Medium²

three solutions to satisfy different installation requirements

GROUND MEDIUM² - COOLING ONLY or HEATING ONLY

WSH-XEE2:



- Water chiller or non-reversible heat pump
- Partial energy recovery



GROUND MEDIUM² - HEAT PUMP

WSHN-XEE2:



- Reversible-cycle heat pump
- Partial energy recovery
- Domestic hot water production with DHW switching valve
-



GROUND MEDIUM² - MULTIFUNCTION

WSHN-XEE2 MF:



- Reversible-cycle heat pump
- Simultaneous production of hot and chilled water



Cooling only unit:

- Production of chilled water (Operation Cooling-only)

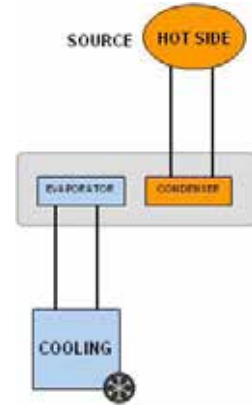
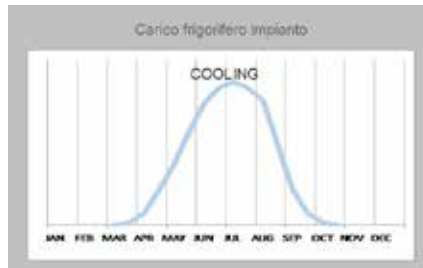

- Production of chilled water (Operation Cooling-only)
- Production of domestic hot water from partial recovery (example post-heat)

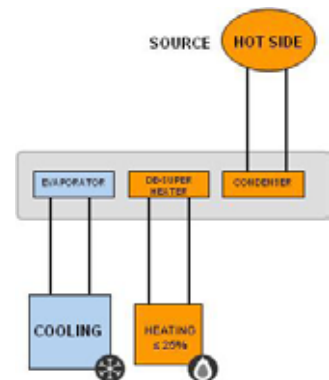
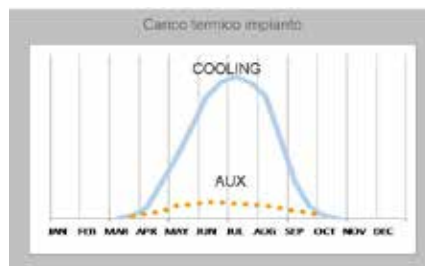

Heating only unit:

- Production of hot water (Operation Heating-only)

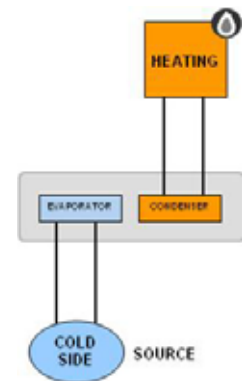
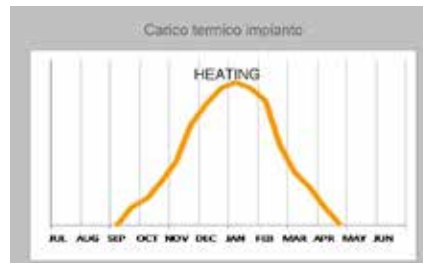

- Production of hot water (Operation Heating-only)
- Production of domestic hot water with 3-way valve
- Alternated production for the System or the DHW circuit

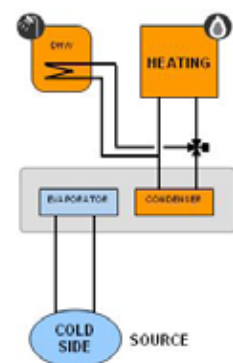
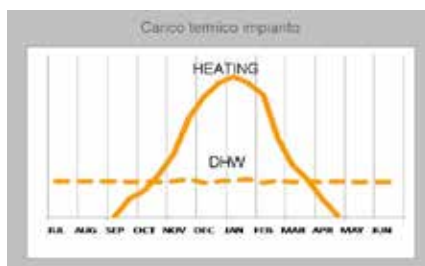

Standard unit technical specifications

Compressor

Hermetic Scroll compressors with orbiting spiral, equipped with motor protective device for overtemperatures, overcurrents and excessive temperatures of the supply gas. They are mounted on rubber antivibration mounts and comes with a full oil charge. The compressors come with a thermal and acoustic insulation jacket. An automatic oil heater prevents the oil from being diluted by the refrigerant when the compressor stops. The compressors are connected in TANDEM on a single refrigerating circuit and have a biphasic oil equalisation.

Structure

Supporting structure made with zinc-magnesium sheet metal that ensures excellent mechanical features and high long-term resistance against corrosion.

Panelling

External panelling in zinc-magnesium sheet, prepainted RAL 9003, clad internally with heatproof and soundproof material. The panels are easy to remove when access to the internal components is required.

Cooling side exchanger

Direct expansion heat exchanger with braze welded stainless steel INOX AISI 316 plates and complete with external thermal/anti-condensation insulation.

The exchanger has Victaulic hydraulic connections.

Heating side exchanger

Direct expansion heat exchanger with braze welded stainless steel INOX AISI 316 plates and complete with external thermal/anti-condensation insulation.

The exchanger has Victaulic hydraulic connections.

Refrigeration circuit

Refrigeration circuit with:

- anti-acid dehydrator filter
- liquid flow and moisture indicator
- electronic expansion valve
- safety high pressure switch
- low pressure transducer
- high pressure transducer
- high pressure safety valve
- low pressure safety valve
- refrigerant charge

Nota: l'unità può operare in solo raffreddamento o in solo riscaldamento

Water circuit

Cooling side

- victaulic connection joints
- differential pressure switch, water side
- drain cock (only with hydronic units option)
- minimum circuit charge pressure switch (only with hydronic units option)
- safety valve (only with hydronic units option)

Heating side

- victaulic connection joints
- differential pressure switch, water side
- drain cock (only with hydronic units option)
- minimum circuit charge pressure switch (only with hydronic units option)
- safety valve (only with hydronic units option)

Electrical panel

The capacity section includes:

- main door lock isolator switch
- isolating transformer for auxiliary circuit power supply
- compressor overload protection (in the range between 12.2 and 80.2)
- compressor protection fuse (in the range between 100.2 and 120.2)
- compressor control contactor
- double winding on compressor for reduction of inrush current (in the range between 100.2 and 120.2)

The control section includes:

- interface terminal with graphic display
- display of the set values, the error codes and the parameter index
- keys for ON/OFF control, cool and heat operating modes, alarm reset
- proportional-integral water temperature control
- daily, weekly programmer of temperature set-point and unit on/off
- set-point compensation with 0-10 V signal
- unit switching on management by local or remote (serial)
- antifreeze protection water side
- compressor overload protection and timer
- prealarm function for water antifreeze and high refrigerant gas pressure
- self-diagnosis system with immediate display of the fault code
- automatic rotation control for compressor starts
- compressor operating hour display
- Input for remote ON/OFF control
- potential-free contact for summer / winter change
- dry contacts to control the cumulative alarm signal remotely
- inlet for demand limit (power input limitation according to a 0÷10V external signal)
- double setpoint enabling
- potential-free contacts for compressor status
- phase monitor
- ECOSHARE function for the automatic management of a group of units
- 0÷10V signal output and potential-free contact for auxiliary heater
- enabling of DHW preparation in relation to remote consent
- numeration of electrical panel cables
- designed for natural cooling management (provided by the customer)
- configuration for single on/off pump or service and source side modulating valve

Accessories

- IFWX - Steel mesh strainer on the water side
- SPCX - Set-point compensation with outdoor air temperature probe
- RCTX - Remote control
- AVIBX - Anti-vibration mount supports
- CMMBX - Serial communication module to supervisor (MO-DBUS)
- CMSLWX - LonWorks serial communication module
- BACX - BACnet serial communication module
- AVIBX - Anti-vibration mount supports
- VS2MCX - Cold side 2-way modulating valve
- VS3MCX - Cold side 3-way modulating valve
- VS2MHX - Hot side 2-way modulating valve
- VS3MHX - Hot side 3-way modulating valve
- VACSHX - Heating side DHW switching valve

Heating only unit

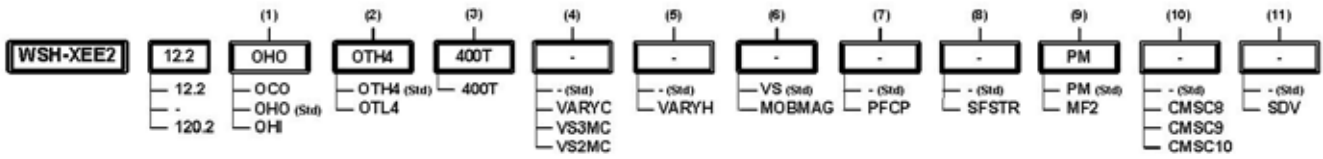

(1) Operation

OCO - Cooling only
 OHO - Heating only (standard)
 OHI - Operation with water circuit change-over

(2) Version

OTH4 - Operating conditions above 4°C (standard)
 OTL4 - Operating conditions below 4°C

(3) Voltage

Supply voltage 400/3/50

(4) Cold side hydronic unit

Refer to the diagrams of the hydronic assembly reported

(5) Hot side hydronic unit

Refer to the diagrams of the hydronic assembly reported

(6) Larger units

VS - Standard enclosure
 MOB MAG - Larger units

(7) Power capacitors

(-) not required (standard)
 PFCP - Power factor correction capacitors (cosφ>0.9)

(8) Soft starter

(-) not required (standard)
 SFSTR - Disposal for inrush current reduction (only for sizes from 12.2 to 80.2)

(9) Phase monitor

PM - Phase monitor (standard)
 MF2 - Multi-function phase monitor

(10) Communication modules

(-) not required (standard)
 CMSC8 - Serial communication module to BACnet supervisor
 CMSC9 - Serial communication module to Modbus supervisor
 CMSC10 - Serial communication module to LonWorks supervisor

(11) Cutoff valve

(-) not required (standard)
 SDV - Cutoff valve on compressor supply and return (only for sizes from 12.2 to 80.2)

FUNCTIONALITIES	DIAGRAM HYDRONIC ASSEMBLIES - HEATING ONLY UNIT			
2-PIPE SYSTEM HOT SIDE	Standard unit (Std)	Unit with VARYFLOW + (VARYH)		
2-PIPE SYSTEM COLD SIDE	Standard unit (Std)	Unit with VARYFLOW + (VARYC)	Unit with 3-way modulating valve (VS3MC)	Unit with 2-way modulating valve (VS2MC)

Unit configuration

Cooling only unit

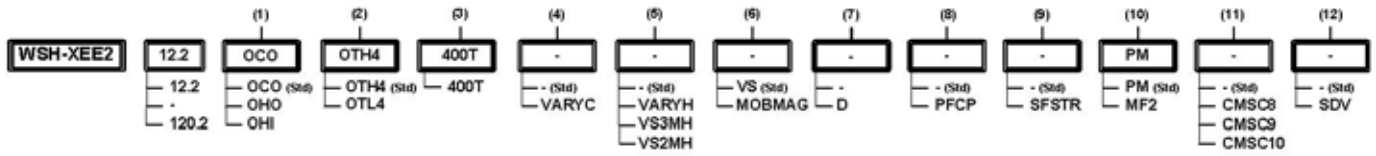

(1) Operation

OCO - Cooling only (standard)
 OHO - Heating only
 OHI - Operation with water circuit change-over

(2) Version

OTH4 - Operating conditions above 4°C (standard)
 OTL4 - Operating conditions below 4°C

(3) Voltage

Supply voltage 400/3/50

(4) Cold side hydronic unit

Refer to the diagrams of the hydronic assembly reported

(5) Hot side hydronic unit

Refer to the diagrams of the hydronic assembly reported

(6) Larger units

VS - Standard enclosure
 MOB MAG - Larger units

(7) Partial recovery device

(-) not required (standard)
 D - Partial energy recovery (only for sizes from 12.2 to 80.2)

(8) Power capacitors

(-) not required (standard)
 PFCP - Power factor correction capacitors (cosfi>0.9)

(9) Soft starter

(-) not required (standard)
 SFSTR - Disposal for inrush current reduction (only for sizes from 12.2 to 80.2)

(10) Phase monitor

PM - Phase monitor (standard)
 MF2 - Multi-function phase monitor

(11) Communication modules

(-) not required (standard)
 CMSC8 - Serial communication module to BACnet supervisor
 CMSC9 - Serial communication module to Modbus supervisor
 CMSC10 - Serial communication module to LonWorks supervisor

(12) Cutoff valve

(-) not required (standard)
 SDV - Cutoff valve on compressor supply and return (only for sizes from 12.2 to 80.2)

FUNCTIONALITIES	DIAGRAM HYDRONIC ASSEMBLIES - COOLING ONLY UNIT			
2-PIPE SYSTEM HOT SIDE	Standard unit (Std)	Unit with VARYFLOW + (VARYH)	Unit with 3-way modulating valve (VS3MH)	Unit with 2-way modulating valve (VS2MH)
2-PIPE SYSTEM COLD SIDE	Standard unit (Std)	Unit with VARYFLOW + (VARYC)		

MOBMAG Larger units

The large cabinet configuration is selected automatically when any hydronic assembly (user or source side) or valve (2-/3-way modulating valve) is selected.

To facilitate the handling, the Large cabinet structure has been revised, the position of components has been changed, and therefore the operations of disassembly are simplified, saving 50% of the time. The instructions for disassembly are reported in detail in the installation and operating manual.

SDV Cutoff valve on compressor supply and return

This option makes it possible to be isolated and substituted without discharging the refrigerant from within the refrigeration circuit. This means that the extraordinary maintenance activities are facilitated.

Option available only for the size from 12.2 to 80.2.

CMSC9 Serial communication module for Modbus supervisor

This enables the serial connection of the supervision system, using Modbus as the communication protocol. It enables access to the complete list of operational variables, commands and alarms. Using this accessory every unit can dialogue with the main supervision systems.

The device is installed and wired built-in the unit.

⚠ The total length of each serial line do not exceed 1000 meters and the line must be connected in bus typology (in/out)

CMSC10 Serial communication module for LonWorks supervisor

This enables the serial connection of the supervision system which uses the LonWorks communication protocol. It enables access to a list of operating variables, commands and alarms which comply with the Echelon® standard.

The device is installed and wired built-in the unit.

⚠ The configuration and management activities for the LonWorks networks are the responsibility of the client.

⚠ LonWorks technology uses the LonTalk® protocol for communicating between the network nodes. Contact the service supplier for further information.

CMSC8 Serial communication module for BACnet supervisor

Allows the serial connection to supervision systems, by using BACnet as communication protocol. It allows the access to the entire list of operation variables, controls and alarms. With this accessory, every unit can communicate with the main supervision systems.

The device is installed and wired built-in the unit.

⚠ The configuration and management activities for the BACnet networks are the responsibility of the client.

⚠ The total length of each serial line do not exceed 1000 meters and the line must be connected in bus typology (in/out)

MF2 Multi-function phase monitor

The multifunction phase monitor controls all phases and their sequence, checks for voltage anomalies (+/-10%), and automatically restores operation of the unit as soon as the power supply returns to normal.

This control allows to:

- protect the internal components of the unit, which are powered by an abnormal voltage, may operate incorrectly or break;
- quickly identify, among the alarms of the unit's components, the real cause of the malfunction due to the sudden change in voltage.

SFSTR Disposal for inrush current reduction

Electronic device that automatically and gradually starts the compressors, thereby reducing the current peak generated in star-triangle start-ups and therefore reduces the mechanical stress on the motor and the electrodynamic stress on the power cables and on the mains.

Option available only for the size from 12.2 to 80.2.

⚠ For size from 100.2 to 120.2 the starting current check is standard. The function is guaranteed by the presence in the motor of the compressor of larger size of a double winding. This solution allows to start the compressor in two stages, obtaining two peaks of reduced current, spaced apart from one another.

PFCP Power factor correction capacitors (cosfi > 0.9)

The component is necessary to lower the phase difference between current and voltage in the electromagnetic components of the unit (e.g. asynchronous motors). The component allows to put the cosfi power factor to values on average higher than 0.9, reducing the network reactive power. This often leads to an economic benefit which the energy provider grants to the final user.

Accessories separately supplied

VS2MHX

Heating side two-way modulating valve

The 2-way source side modulating valve, installed on the source side exchanger outlet, modulates the flow of water in response to a 0-10 V signal from the unit's controller.

2-way modulating valve pressure drops (VS2MHX - VS2MCX)

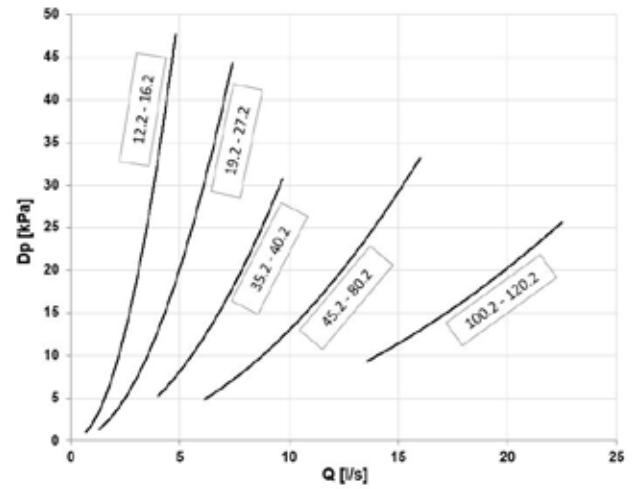

Q = Water flow rate [l/s]
DP = Pressure drops [kPa]

VS2MCX

Cooling side two-way modulating valve

The 2-way modulating valve, installed on the cold side exchanger inlet, modulates the water flow in response to a 0-10 V signal from the unit's controller.

VS3MHX

Heating side three-way modulating valve

The 3-way modulating valve connects the hot side exchanger inlet and outlet, thus bypassing the exchanger and reducing the flow of water inside it, while keeping the machine's delivery flow constant.

The valve modulation is managed by a 0-10V signal generated by the unit electronic control.

Perdite di carico valvola 3 vie modulante (VS3MHX-VS3MCX)

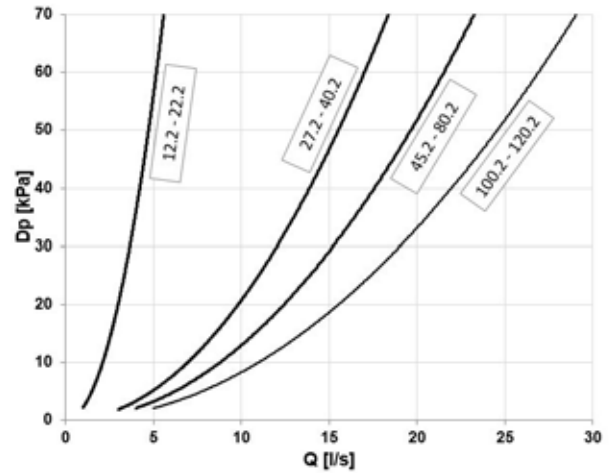

Q = Water flow rate [l/s]
DP = Pressure drops [kPa]

VS3MCX

Cooling side three-way modulating valve

The 3-way modulating valve connects the cold side exchanger inlet and outlet, thus bypassing the exchanger and reducing the flow of water inside it, while keeping the machine's delivery flow constant.

The valve modulation is managed by a 0-10V signal generated by the unit electronic control.

VACSUX

User side DHW switching valve

The utility side DHW switching valve is also supplied as a separate accessory.

The DHW is called by the closure of the potential-free contact present in the unit electric panel. In heating, the control regulates the 3-way valve commutation because it deviates the flow-rate from installation to DHW storage tank, changes the installation set into the DHW one, thermoregulates and activates or deactivates the compressors depending on the distance from the DHW set. In cooling, the control switches off the compressors due to the mode changing, regulates the 3-way valve commutation and starts the compressors after the safety time owed to on/off.

For sizes from 12.2 to 22.2 the DHW switching valve is 2".

For sizes from 27.2 to 40.2 the DHW switching valve is 2 1/2".

For sizes from 45.2 to 80.2 the DHW switching valve is 3".

For sizes from 100.2 to 120.2 the DHW switching valve is 4".

The DHW switching valve has a IP 40 protection degree.

It is therefore compulsory that client provides a protection for the external liquid valve.

DHW switching valve pressure drops

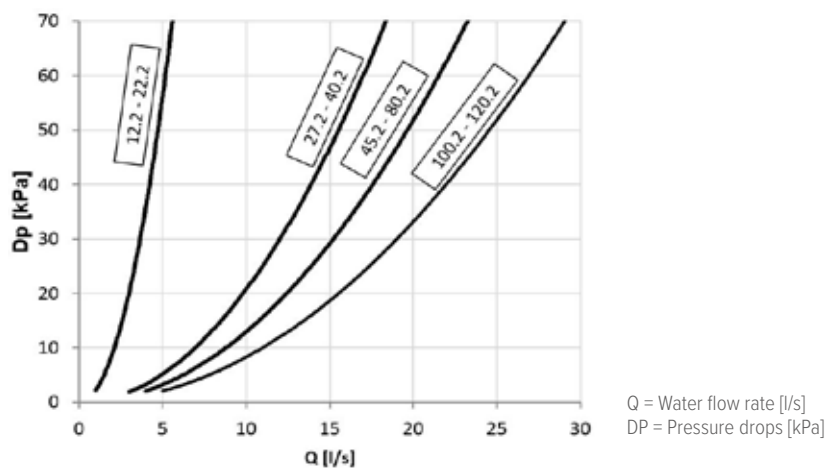

IFWX

Steel mesh strainer water side

The device prevents any impurity in the water circuit from soiling the exchanger. The stainless steel mesh mechanical strainer must be placed on the water inlet line. It needs to be easy to remove for periodical maintenance and cleaning operations. It can be used on the user and source side.

⚠ Check for the presence of the required hydraulic shut-off valves in the system, in order to undertake periodical maintenance.

Pressure drops of steel mesh strainer water side

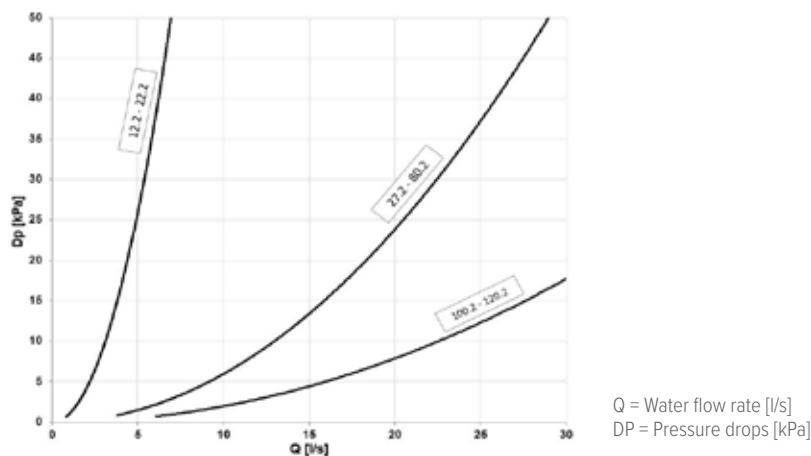

Accessories separately supplied

CMMBX Serial communication module to supervisor (Modbus)

This enables the serial connection of the supervision system, using Modbus as the communication protocol. It enables access to the complete list of operational variables, commands and alarms. Using this accessory every unit can dialogue with the main supervision systems.

⚠ The total length of each serial line do not exceed 1000 meters and the line must be connected in bus typology (in/out)

CMSLWX LonWorks serial communication module

This enables the serial connection of the supervision system which uses the LonWorks communication protocol. It enables access to a list of operating variables, commands and alarms which comply with the Echelon® standard.

⚠ The configuration and management activities for the LonWorks networks are the responsibility of the client.

⚠ LonWorks technology uses the LonTalk® protocol for communicating between the network nodes. Contact the service supplier for further information.

BACX BACnet serial communication module

Allows the serial connection to supervision systems by using BACnet-IP as a communication protocol. It allows the access to the entire list of operating variables, controls and alarms. With this accessory every unit can communicate with the main supervision systems.

⚠ The configuration and management activities for the BACnet networks are the responsibility of the client.

⚠ The total length of each serial line do not exceed 1000 meters and the line must be connected in bus typology (in/out)

RCTX Remote control

This option allows to have full control over all the unit functions from a remote position. It can be easily installed on the wall and has the same aspect and functions of the user interface on the unit.

⚠ All device functions can be repeated with a normal portable PC connected to the unit with an Ethernet cable and equipped with an internet navigation browser.

⚠ The device should be installed on the wall using suitable plugs, electrically hooked up and connected to the unit (installation and wiring are the responsibility of the Customer). Max. remote distance 350 m without auxiliary supply.

⚠ Data and power supply serial connection cable n.1 twisted and shielded pair. Diameter of the individual conductor 0.8 mm.



SPCX Set-point compensation with outdoor air temperature probe

The setpoint compensation with air probe changes the calibration of the setpoint in relation to the temperature of the outside air and this reduces energy costs. The probe is connected to the unit's main control module and the maximum length of the connection cable is 20 meters. The sensor must not be influenced by factors that might affect its reading (for instance direct sunlight, contact with external heat sources, etc.) and therefore must be placed in a sheltered place.

AVIBX Anti-vibration mount supports

The rubber antivibration mounts are attached in special housing on the support frame and serve to smooth the vibrations produced by the unit thus reducing the noise transmitted to the support structure.

OTH4 Operating conditions above 4°C - Performance

SIZE			12.2	16.2	19.2	22.2	27.2	35.2	40.2	45.2	55.2	60.2	70.2	80.2	100.2	120.2
Radiant panel																
Operation Heating-only																
Heating capacity (EN14511:2018)	1	kW	42,7	59,9	71,0	83,4	101	131	149	177	209	233	267	301	370	437
Total power input (EN14511:2018)	2	kW	7,79	11,2	13,2	15,2	18,1	24,7	27,8	33,2	39,5	44,4	50,6	54,0	69,9	84,1
COP (EN 14511:2018)	3		5,49	5,36	5,38	5,51	5,55	5,32	5,36	5,33	5,28	5,24	5,29	5,57	5,30	5,19
Operation Cooling only																
Cooling capacity (EN14511:2018)	6	kW	48,0	66,9	81,0	91,7	114	148	166	199	234	267	300	336	407	477
Total power input (EN14511:2018)	2	kW	8,08	11,7	13,8	16,9	18,5	25,4	28,4	34,3	41,5	47,2	54,1	62,5	73,9	88,0
EER (EN 14511:2018)	7		5,94	5,71	5,85	5,43	6,19	5,81	5,85	5,82	5,65	5,65	5,54	5,38	5,51	5,42
Unità terminali																
Operation Heating-only																
Heating capacity (EN14511:2018)	4	kW	41,3	57,6	68,4	80,7	96,5	125	143	169	200	228	256	289	354	419
Total power input (EN14511:2018)	2	kW	9,54	13,3	15,7	19,3	21,8	29,0	32,8	39,0	46,5	52,4	59,2	67,1	83,1	101
COP (EN 14511:2018)	3		4,33	4,35	4,35	4,19	4,44	4,31	4,34	4,32	4,29	4,36	4,33	4,30	4,26	4,17
Operation Cooling only																
Cooling capacity (EN14511:2018)	8	kW	35,6	49,8	59,3	68,4	84,2	109	124	147	173	197	222	250	305	356
Total power input (EN14511:2018)	2	kW	7,50	10,6	12,5	15,7	17,5	23,7	26,8	31,8	38,1	43,2	48,6	55,3	68,4	82,3
EER (EN 14511:2018)	7		4,75	4,68	4,74	4,36	4,82	4,59	4,61	4,62	4,54	4,56	4,57	4,52	4,46	4,32
SEER	9		5,36	5,25	5,30	5,24	5,59	5,77	5,87	5,72	5,38	5,38	5,51	5,30	5,46	5,39
Radiatori																
Operation Heating-only																
Heating capacity (EN14511:2018)	5	kW	38,7	53,7	63,0	74,3	88,5	115	131	155	185	212	236	266	326	387
Total power input (EN14511:2018)	2	kW	12,0	16,3	19,3	23,0	26,5	35,2	39,6	47,1	56,4	63,4	71,2	79,9	102	124
COP (EN 14511:2018)	3		3,22	3,29	3,27	3,23	3,34	3,28	3,32	3,30	3,28	3,34	3,32	3,33	3,20	3,11

The Product is compliant with the Erp (Energy Related Products) European Directive. It includes the Commission delegated Regulation (EU) No 811/2013 (rate heat output ≤70 kW at specified reference conditions) and the Commission delegated Regulation (EU) No 813/2013 (rated heat output ≤400 kW at specified reference conditions).
 Contains fluorinated greenhouse gases(GWP 2087,5)

1. Data referred to the following conditions: Cold side exchanger water temperature 30/35°C. Hot side exchanger water temperature 10/7°C. Performance data calculated with reference to EN14511:2018
2. The total power draw is calculated by adding the compressor's power draw + the draw required to overcome the internal service and source side pressure drops + the control circuit power draw
3. COP (EN 14511:2018) heating performance coefficient. Ratio between delivered heating capacity and power input in compliance with EN 14511:2018
4. Data referred to the following conditions: Cold side exchanger water temperature 40/45°C. Hot side exchanger water temperature 10/7°C. Performance data calculated with reference to EN14511:2018
5. Data referred to the following conditions: Cold side exchanger water temperature 50/55°C. Hot side exchanger water temperature 10/7°C. Performance data calculated with reference to EN14511:2018
6. Data referred to the following conditions: Cold side exchanger water temperature 23/18°C. Hot side exchanger water temperature 30/35 °C. Performance data calculated with reference to EN14511:2018
7. EER (EN 14511:2018) cooling performance coefficient. Ratio between delivered cooling capacity and power input in compliance with EN 14511:2018
8. Data referred to the following conditions: Cold side exchanger water temperature 12/7°C. Hot side exchanger water temperature 30/35 °C. Performance data calculated with reference to EN14511:2018
9. Data calculated according to the EN 14825:2018 Regulation

General technical data

OTH4 Operating conditions above 4°C - Construction

SIZE		12.2	16.2	19.2	22.2	27.2	35.2	40.2	45.2	55.2	60.2	70.2	80.2	100.2	120.2
Compressor															
Type of compressors		Scroll													
Refrigerant		R-410A													
No. of compressors	Nr	2	2	2	2	2	2	2	2	2	2	2	2	2	2
Std Capacity control steps	Nr	3	3	3	3	3	3	3	3	3	2	3	2	3	2
Oil charge	l	3,0	5,8	5,8	5,8	6,6	8,0	10,1	11,0	13,1	12,6	12,6	12,6	12,6	12,6
Refrigerant charge	kg	3,2	6,8	7,7	8,0	10,2	10,8	12,4	13,0	16,0	17,0	20,8	22,0	32,0	31,0
Refrigeration circuits	Nr	1	1	1	1	1	1	1	1	1	1	1	1	1	1
Internal exchanger															
Type of internal exchanger	1	PHE													
No. of internal exchangers	Nr	1	1	1	1	1	1	1	1	1	1	1	1	1	1
Water flow-rate (User Side)	2 l/s	1,7	2,4	2,8	3,3	4,0	5,2	5,9	7,0	8,2	9,4	10,6	11,9	14,5	16,9
External exchanger															
Type of external exchanger	1	PHE													
No. of external exchangers	Nr	1	1	1	1	1	1	1	1	1	1	1	1	1	1
Water flow rate (Source Side)	2 l/s	2,1	2,9	3,4	4,0	4,9	6,3	7,2	8,5	10,1	11,4	12,9	14,6	17,9	21,0
Connections															
Water fittings (Standard units)		1" 1/4	1" 1/4	1" 1/4	1" 1/4	2" 1/2	2" 1/2	2" 1/2	2" 1/2	2" 1/2	2" 1/2	2" 1/2	2" 1/2	3"	3"
Water fittings (Large units)		2"	2"	2"	2"	3"	3"	3"	3"	3"	3"	3"	3"	4"	4"
Water circuit															
Maximum water side pressure	3 MPa	1	1	1	1	1	1	1	1	1	1	1	1	1	1
Min. installation water contents	l	300	480	480	480	750	1000	1000	1000	1600	2050	2050	2650	2550	3800
Power supply															
Standard power supply	V	400/3/50	400/3/50	400/3/50	400/3/50	400/3/50	400/3/50	400/3/50	400/3/50	400/3/50	400/3/50	400/3/50	400/3/50	400/3/50	400/3/50

1. PHE = plate exchanger

2. Data referred to the following conditions: Internal exchanger water temperature 12/7°C. External exchanger water temperature 30/35 °C.

3. Conditions for the circuit on the utility side and the circuit on the source side. In configurations with hydronic units, the maximum pressure on the water side is 600 kPa.

Electrical data

Supply voltage 400/3/50

SIZE		12.2	16.2	19.2	22.2	27.2	35.2	40.2	45.2	55.2	60.2	70.2	80.2	100.2	120.2
F.L.A. - Full load current at max admissible conditions															
F.L.A. - Total	A	23,8	31,5	36,4	44,9	51,8	66,8	74,9	89,6	104	119	133	148	188	228
F.L.I. - Full load power input at max admissible conditions															
F.L.I. - Total	kW	14,0	19,5	22,4	26,3	30,2	39,6	44,6	53,1	63,7	72,2	81,0	90,0	116	140
M.I.C. Maximum inrush current															
M.I.C. - Value	A	111	126	133	189	196	256	302	340	355	370	468	482	458	499
M.I.C. with soft start accessory	A	65,2	76,2	80,0	111	118	154	180	201	216	230	284	299	-	-

Electrical data refer to standard units; according to the installed accessories, the data can suffer some variations.

Power supply: 400/3/50 Hz. Voltage variation: max. +/-10%

Voltage unbalance between phases: max 2 %

For non standard voltage please contact Clivet technical office

Units are in compliance with the europeans law CEI EN 60204 and CEI EN 60335

Sound levels

SIZE	Sound power level (dB)								Sound power level dB(A)	Sound pressure level dB(A)
	Octave band (Hz)									
	63	125	250	500	1000	2000	4000	8000		
12.2	78	69	62	56	52	44	43	38	60	44
16.2	78	71	66	63	53	49	46	41	64	49
19.2	78	73	67	63	55	51	47	42	65	49
22.2	78	73	65	62	55	52	47	42	64	49
27.2	78	73	66	62	56	54	49	44	64	49
35.2	81	83	80	67	61	61	52	45	74	58
40.2	81	79	80	67	65	63	55	50	74	58
45.2	81	78	80	69	66	62	55	48	74	58
55.2	81	80	83	70	68	65	57	50	77	60
60.2	81	80	83	71	69	65	57	50	77	61
70.2	82	80	85	73	72	68	60	51	79	63
80.2	82	80	85	73	74	70	61	52	80	63
100.2	83	81	86	74	75	71	62	53	81	64
120.2	84	82	87	75	76	72	63	54	82	65

Sound levels refer to units with full load under nominal test conditions.

The sound pressure level refers to a distance of 1 meter from the outer surface of the unit operating in open field.

Measurements are carried out in compliance with UNI EN ISO 9614-1

The sound power data is not certified by Eurovent.

Data referred to the following conditions:

Entering / leaving exchanger water temperature user side 12/7°C

Entering / leaving exchanger water temperature source side 30/35°C

General technical data

Admissible water flow rates

Min. (Qmin) and max. (Qmax) water flow-rates admissibles for the correct unit operation.

		12.2	16.2	19.2	22.2	27.2	35.2	40.2	45.2	55.2	60.2	70.2	80.2	100.2	120.2
Heating side	Min [l/s]	1,1	1,4	1,4	1,4	2,4	1,9	3,2	3,2	3,9	3,8	5,4	5,4	12,5	13,2
	Max [l/s]	4,2	4,8	4,9	5,3	8,8	9,3	11,4	12,2	15,0	15,4	18,3	19,0	28,0	29,0
Cooling side	Min [l/s]	1,1	1,4	1,4	1,4	2,3	3,1	3,1	3,9	3,9	5,1	5,1	6,0	10,6	10,6
	Max [l/s]	3,5	4,4	4,9	5,1	8,5	11,5	11,5	14,5	15,0	18,0	18,5	21,5	27,0	27,0

Correction factors for glycol use

% ethylene glycol by weight		5%	10%	15%	20%	25%	30%	35%	40%
Freezing temperature	°C	-2,0	-3,9	-6,5	-8,9	-11,8	-15,6	-19,0	-23,4
Safety temperature	°C	3	1	-1	-4	-6	-10	-14	-19
Cold side exchanger chiller power factor	-	0,995	0,990	0,985	0,981	0,977	0,974	0,971	0,968
Cold side exchanger compressor power draw factor	-	0,997	0,993	0,990	0,988	0,986	0,984	0,982	0,981
Cold side exchanger glycol solution flow factor	-	1,003	1,010	1,020	1,033	1,050	1,072	1,095	1,124
Cold side exchanger pressure drop factor	-	1,029	1,060	1,090	1,118	1,149	1,182	1,211	1,243

Fouling Correction Factors

m ² °C / W	EVAPORATOR		CONDENSER	
	F1	FK1	F2	FK2
0.44 x 10 (-4)	1	1	1	1
0.88 x 10 (-4)	0,97	0,99	0,97	1,08
1.76 x 10 (-4)	0,94	0,98	0,92	1,05

F1 = Cooling capacity correction factors

FK1 = Compressor power input correction factor

Overload and control device calibrations

		INTERVENTION	RESET	VALUE
High pressure switch (gas side)	[kPa]	4050	3300	-
Low pressure alarm (gas side)	[kPa]	450	600	-
Low pressure switch (GEO) (gas side)	[kPa]	200	350	-
Antifreeze protection	[°C]	4	6,0	-
High pressure safety valve (gas side)	[kPa]	-	-	4500
Low pressure safety valve (gas side)	[kPa]	-	-	2950
Max no. of compressor starts per hour (gas side)	[n°]	-	-	10
Differential pressure switch (water side)	[kPa]	2,7 (8*)	5 (10,5*)	-
Max. pressure without hydronic assembly (water side)	[kPa]	-	-	1000
Max. pressure with hydronic assembly (water side)	[kPa]	-	-	600
Safety valve calibration (water side) (1)	[kPa]	-	-	600

(1) Available only with hydronic assembly option

(*) Size 100.2 - 120.2

Cooling only unit

Operating Range (Cooling)

Size 12.2

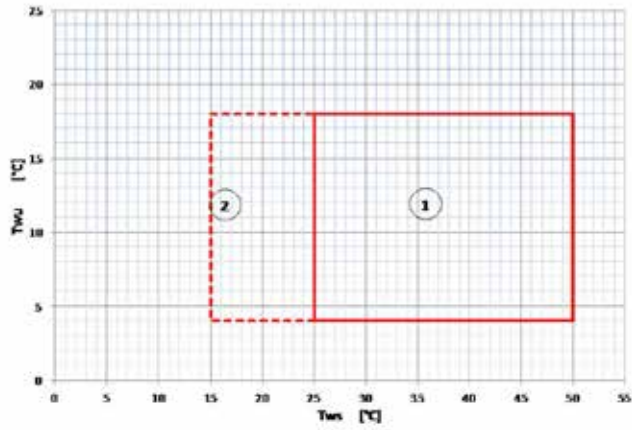

Size 16.2

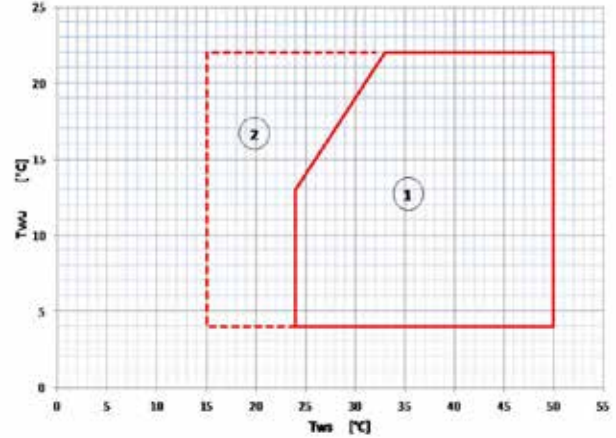

Size 19.2-22.2-27.2-30.2-40.2-45.2

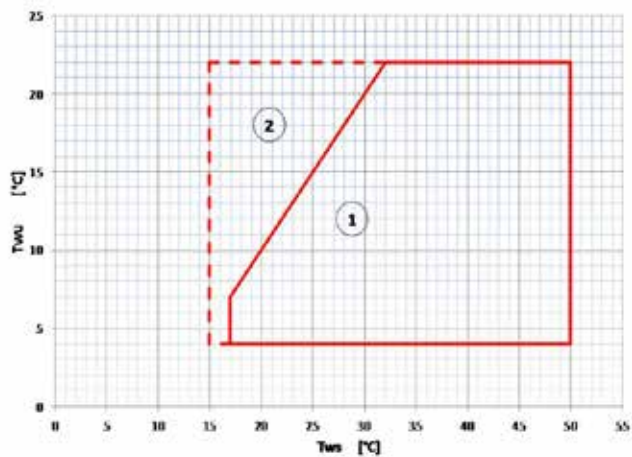

Size 55.2-60.2-70.2-80.2-100.2-120.2

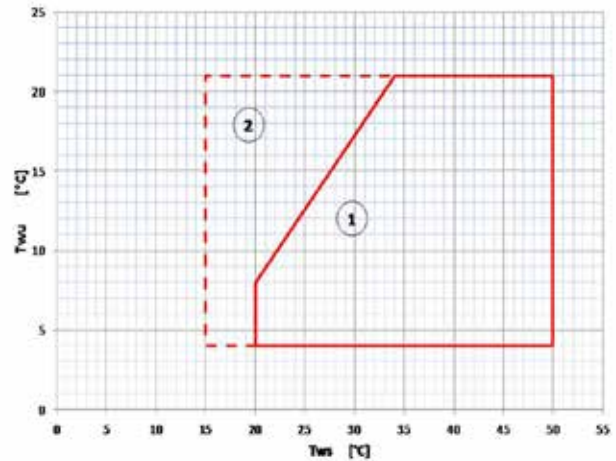

T_{w_w} [°C] = Cold side water outlet temperature

T_{w_s} [°C] = Hot side water outlet temperature

The limits refer to $DT=5$ °C on both the hot and cold sides

1. Normal operating range
2. Range of operation with modulating valve or hot side regulating (optional configurations)

General technical data

Heating only unit

Operating Range (Heating) - OTH4 - Operating conditions above 4°C

Size 12.2

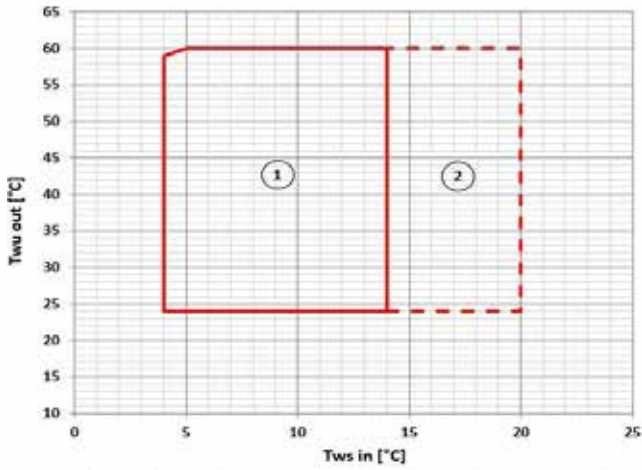

Size 16.2

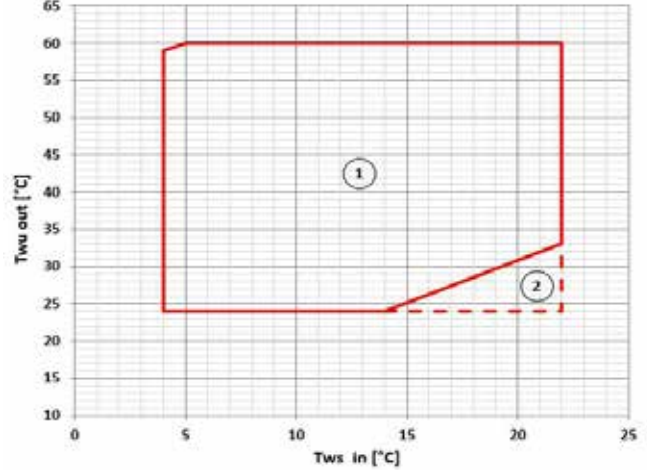

Size 19.2-22.2-27.2-35.2-40.2-45.2

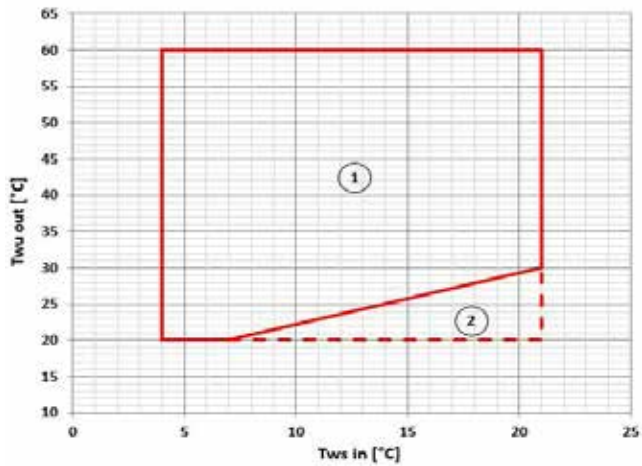

Size 55.2-60.2-70.2-80.2-100.2-120.2

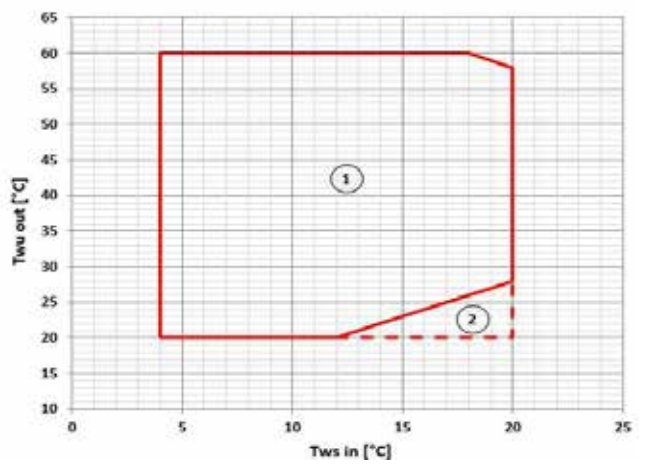

Twu [°C] = Hot side water outlet temperature

Tws [°C] = Cold side water outlet temperature

The limits refer to $\Delta T=5$ °C on both the hot and cold sides

1. Normal operating range
2. Range of operation with modulating valve or hot side regulating (optional configurations)

Heating only unit

Operating Range (Heating) - OTL4 - Operating conditions below 4°C

Size 12.2

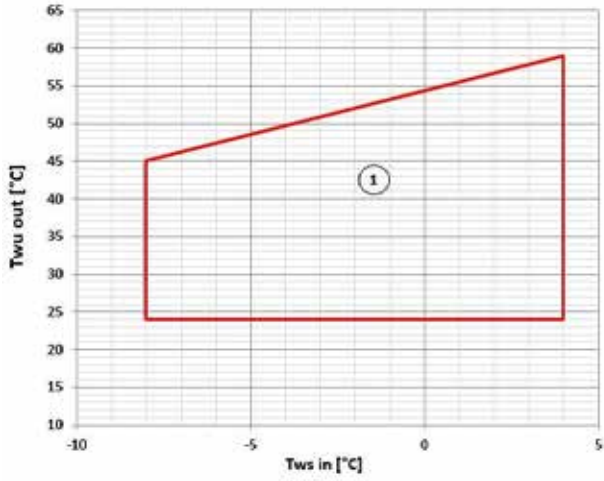

Size 16.2

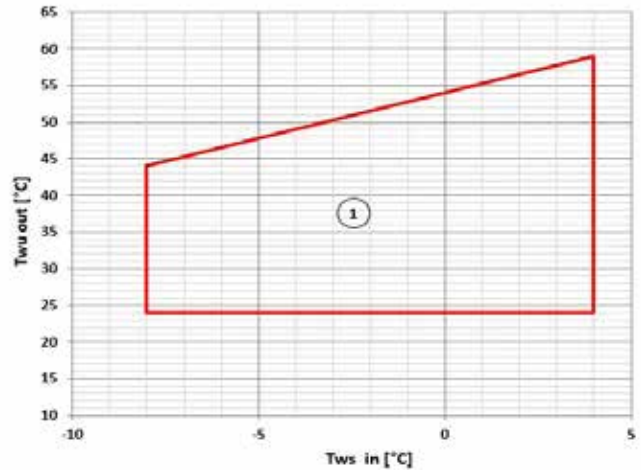

Size 19.2-22.2-27.2-35.2-40.2-45.2

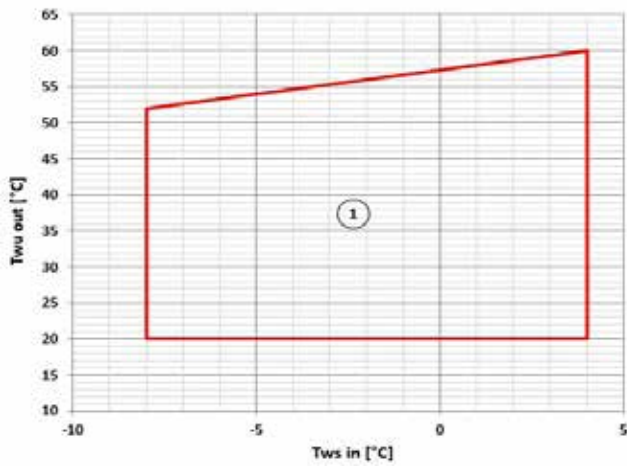

Size 55.2-60.2-70.2-80.2-100.2-120.2

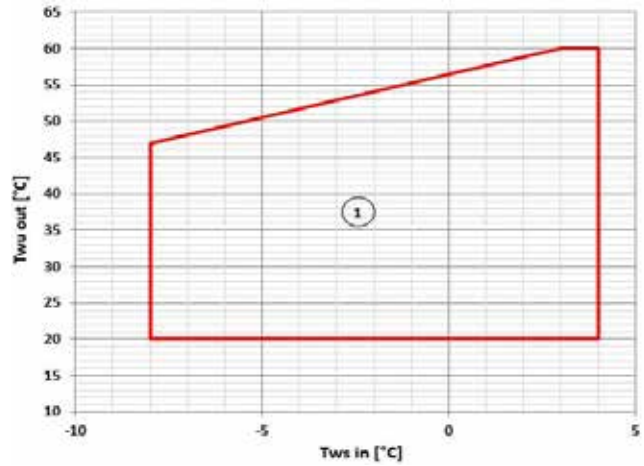

Twu [°C] = Hot side water outlet temperature

Tws [°C] = Cold side water outlet temperature

The limits refer to $\Delta T=5^\circ\text{C}$ on both the hot and cold sides

1. Operating range in which a glycol/water mix must be used, given the water temperature at the cold side exchanger outlet

Electronic control

Description of step start-up control

The electronic control allows to manage the unit depending on the requested load.

The compressor power steps are activated to maximise efficiency from the lowest to the highest setting.



Main controls

Leaving water temperature control with PID algorithm: it keeps the leaving mean temperature to a set value.

- Auto-adaptive switching on differential: guarantees the compressors minimum operating time in systems with low water content.
- Condensation control based on pressure
- Pre-alarms at automatic reset: in case of alarm it is allowed a certain number of restarts before the definitive lock.
- Compressor operating hour calculation
- Compressor start calculation
- Control and continuous management of the compressor operating conditions to guarantee the unit operating also in extreme conditions
- Water temperature check (when used) to avoid the pipe freezing
- Alarm log
- Autostart after voltage drop
- Local or remote control

Unit status display

Attraverso l'interfaccia utente è possibile visualizzare:

- stato e modo di funzionamento delle unità;
- temperatura ingresso/uscita acqua;
- temperature e pressioni del circuito frigorifero;
- segnalazione allarmi e anomalie in corso.

Probe, transducer and parameter display

A user interface dedicated section allows the maintenance or technical assistance personnel to control the unit operating stata. This section is accessible only by specialized personnel.

Management of more units in cascade (ECOSHARE)

It allows the management of several units hydraulically connected up to 1 master and 6 slave maximum.

Units must be of the same type: all reversible heat pumps, or all cool only, or all heat only.

Sizes can be different.

The communication among the units is via a BUS serial cable allowing:

- Supply water set-point setting of the slave units
- Setting of logics that increase the system energy efficiency
- Unit operating hours balancing
- Unit management in case of damage (only on slave unit)
- Hydronic assembly switch-off management of units not used

Remote control (RCTX)

The remote control allows the full control of all unit functions from remote position.

It can be easily installed on the wall and has the same aspect and functions of the user interface on the unit.

Natural Cooling functions

Enabling the Natural Cooling functions, the unit is able to independently manage a system for cold production using source water in the event the temperature conditions of the fluid are favorable.

In this case, the source is managed as if it were the first unit available capacity step and can be used to cover the 100% of the cooling load or also, in integration to the compressors, to cover a part of the cold demand by resetting or reducing the compressor power input. The Natural Cooling installation should include the following additional components (not supplied by Clivet):

1) Natural Cooling water/water exchanger (SCNC in the main scheme): this exchanger shall be suitably dimensioned according to the fluid temperature, user and source side, and according to the pressure drop of the remaining part of the installation and to the unit available static pressure if pumps are not built-in.

2) Two 3-way on/off or equivalent valves (VNCS and VNCU in the main scheme): one on the source circuit and one on the user circuit. Also these have to be suitably dimensioned according to the expected flow rates.

For the correct operation of the Natural Cooling function, the set point control must be set on supply (parameter 436 Tiporeg).

In the installation set up phase it will be necessary to remotely the probe on the source input water upstream of the switching valve source side (VNCS).

The unit can be selected with or without hydronic assemblies user and source side: the system must be able to absorb/manage the flow rate/head variations due to the heater change after the Natural Cooling exchanger insertion and exclusion.

The unit control provides an on/off signal to enable the Natural Cooling by switching the valves.

The Natural Cooling is enabled if the two following conditions are satisfied:

1) the entering water temperature, source side, must be lower than the cooling set point plus a delta defined by parameter 365 DeltaNC (the value can be positive or negative) $[T_{ws_in} < (Set_cooling + \Delta NC)]$

2) the entering water temperature, user side, must be higher than the entering water temperature, source side, plus a delta defined by parameter 366 IsteresiStopNC (the value can be only positive) $[T_{ws_in} < (T_{wu_in} + IsteresiStopNC)]$

If one of these two conditions is not satisfied the Natural Cooling is disabled.

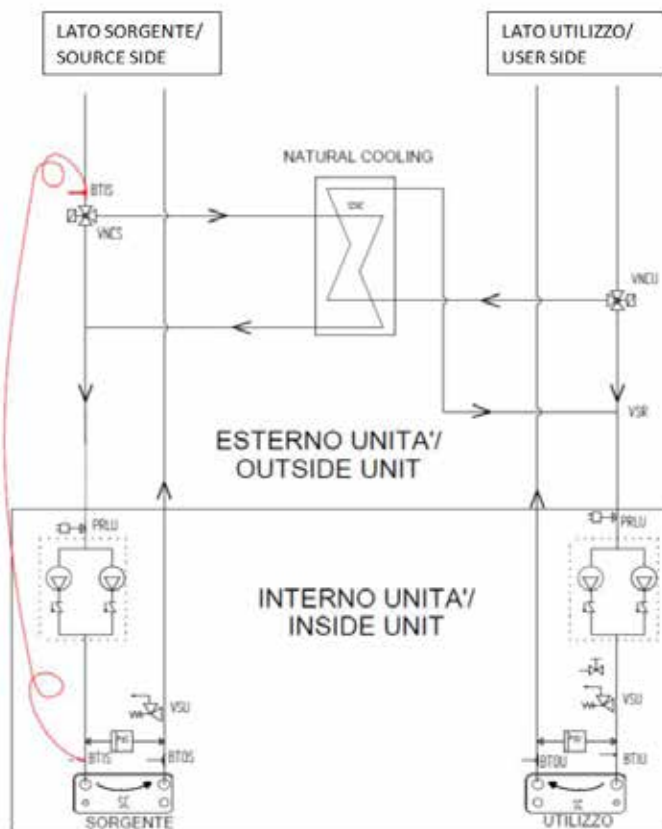

- PDU Differential pressure switch, user side
- PDS Differential pressure switch, source side
- PRLU Installaton load pressure switch adjusted at 0.5 bar
- SC Plate heat exchanger
- VSU Safety valve adjusted at 6 bar (only if pumps or valves are present)
- VSR Exhaust valve
- BTIS Entering temperature probe, source side (to remotely)
- BTOS Leaving temperature probe, source side
- BTIU Entering temperature probe, user side
- BTOU Leaving temperature probe, user side
- VNCS Natural Cooling valve, source side (provided by the Customer)
- VNCU Natural Cooling valve, user side (provided by the Customer)
- SCNC Natural Cooling exchanger (provided by the Customer)

Configurations

Cold side hydronic unit

Standard unit (-)

Configuration without cold side hydronic assembly, equipped with components as described on the water diagram key.

All water fittings are Victaulic type. It is possible to control an external pump by an on/off or 0-10V signal.

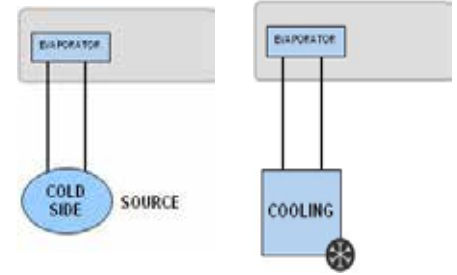

Cold side exchanger pressure drop curves - OTH4 - Operating conditions above 4°C

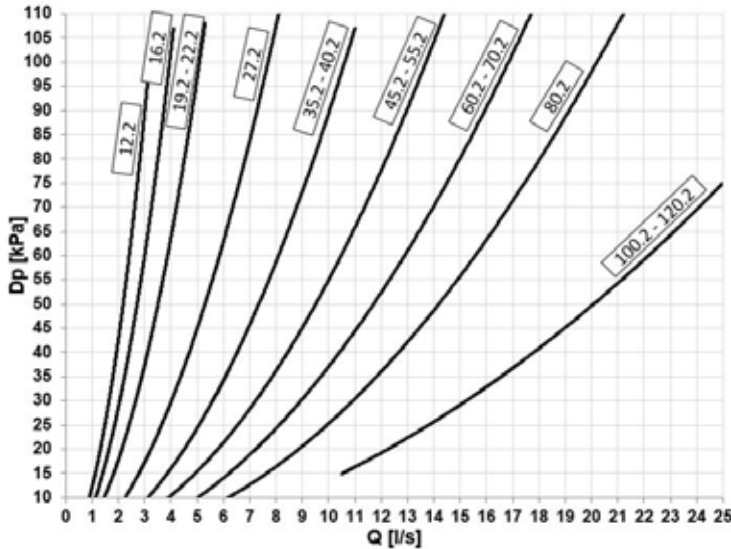

The pressure drops on the water side are calculated by considering an average water temperature at 7°C.

Q = Water flow rate[l/s]
DP = Pressure drops [kPa]

To the cold side exchanger pressure drops must be added the pressure drops of the steel mesh mechanical filter that must be placed on the water input line. It is a device compulsory for the correct unit operation, and it is available as accessory IFWX.

Admissible cold side water flows - OTH4 - Operating conditions above 4°C

Min. (Qmin) and max. (Qmax) water flow-rates admissible for the correct unit operation.

SIZE		12.2	16.2	19.2	22.2	27.2	35.2	40.2	45.2	55.2	60.2	70.2	80.2	100.2	120.2
Cooling side	Qmin	1,1	1,4	1,4	1,4	2,3	3,1	3,1	3,9	3,9	5,1	5,1	6,0	10,6	10,6
	Qmax	3,5	4,4	4,9	5,1	8,5	11,5	11,5	14,5	15,0	18,0	18,5	21,5	27,0	27,0

Water diagram

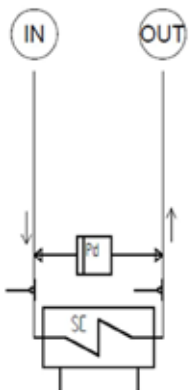

IN = Cold side inlet
OUT = Cold side outlet
PD = Differential pressure switch
SC= Plate heat exchangers

Cold side exchanger pressure drop curves - OTL4 Operating conditions below 4°C

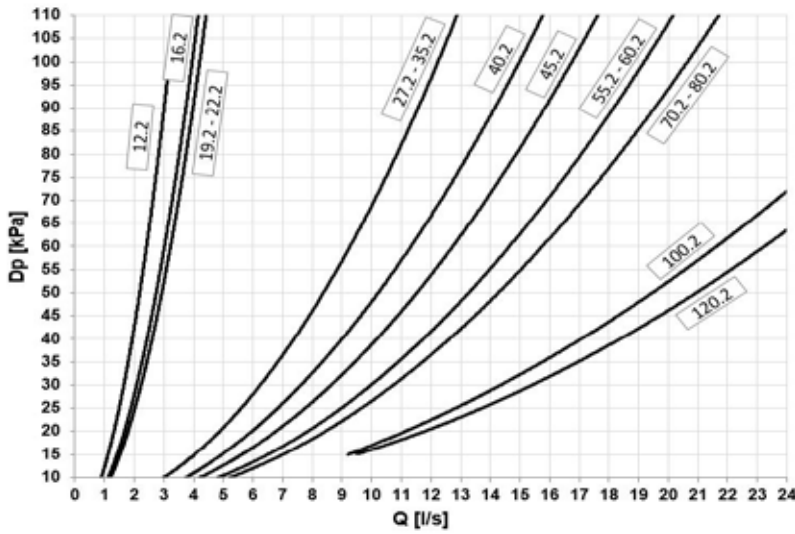

The pressure drops on the water side are calculated by considering an average water temperature at 7°C.

Q = Water flow rate [l/s]
DP = Pressure drops [kPa]

To the cold side exchanger pressure drops must be added the pressure drops of the steel mesh mechanical filter that must be placed on the water input line. It is a device compulsory for the correct unit operation, and it is available as accessory IFWX.

Admissible cold side water flows - OTL4 - condizioni operative inferiori ai 4°C

Min. (Qmin) and max. (Qmax) water flow-rates admissibles for the correct unit operation.

SIZE		12.2	16.2	19.2	22.2	27.2	35.2	40.2	45.2	55.2	60.2	70.2	80.2	100.2	120.2
Cooling side	Qmin	0,9	1,1	1,2	1,2	3,0	3,0	3,7	4,2	4,8	4,8	5,4	5,4	9,2	9,5
	Qmax	4,0	4,7	4,8	4,8	13,5	13,5	16,5	18,5	21,0	21,0	23,0	23,0	28,0	30,0

Water diagram

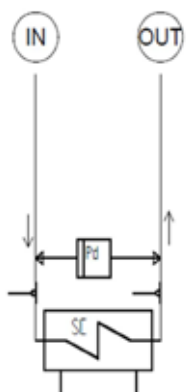

IN = Cold side inlet
OUT = Cold side outlet
PD = Differential pressure switch
SC = Plate heat exchangers

Configurations

Cold side hydronic unit

Unit with VARYFLOW + (VARYC)

Configuration with 2 centrifugal electric pumps arranged in parallel and controlled by inverter, with housing and impeller made with AISI 304 stainless steel, and components as described on the water diagram key. All water fittings are Victaulic type. The electric pumps are equipped with three-phase electric motor with IP55-protection and complete with thermoformed insulated casing.

The control, modulates the water flow-rate keeping constant the delta T.

If the water temperature is in critical conditions, it allows to extend the unit operating ranges guaranteeing its operating, automatically reducing the water flow-rate.

In the event of one of the two pumps is temporarily unavailable, it guarantees about the 80% of the nominal flow-rate.

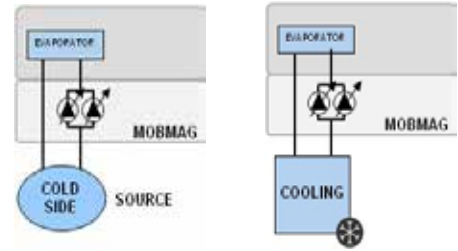

Available pressure Size 12.2

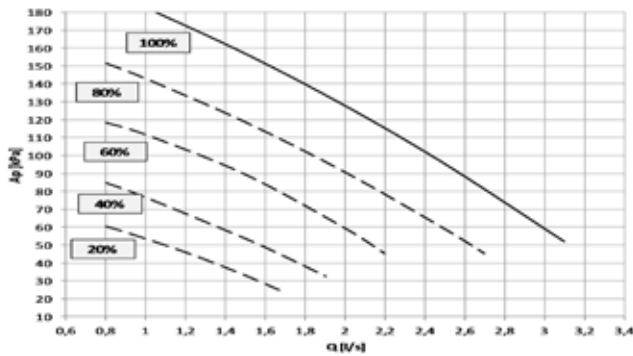

Q = Water flow rate [l/s] Ap = Pressure head, available to the unit fittings [kPa]

Absorption curves Size 12.2

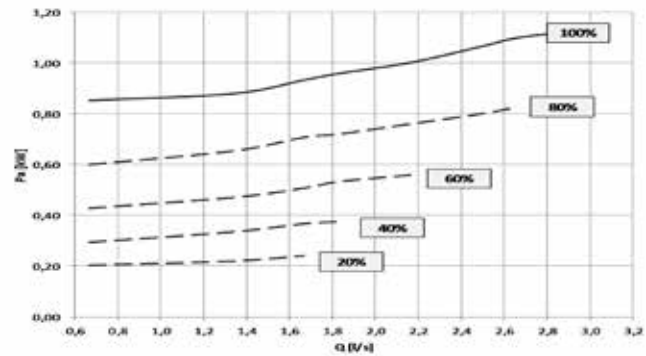

Q = Water flow rate [l/s] Pa = Electrical power draw [kW]

Available pressure Size 16.2

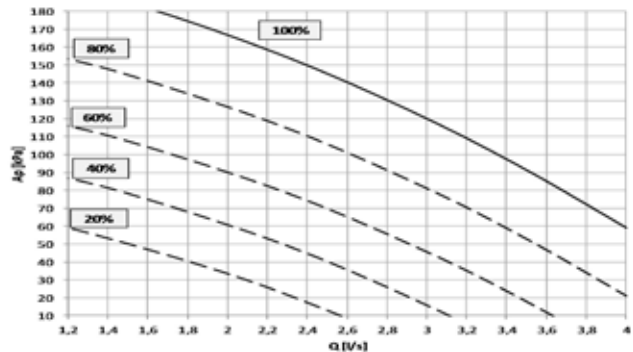

Q = Water flow rate [l/s] Ap = Pressure head, available to the unit fittings [kPa]

Absorption curves Size 16.2

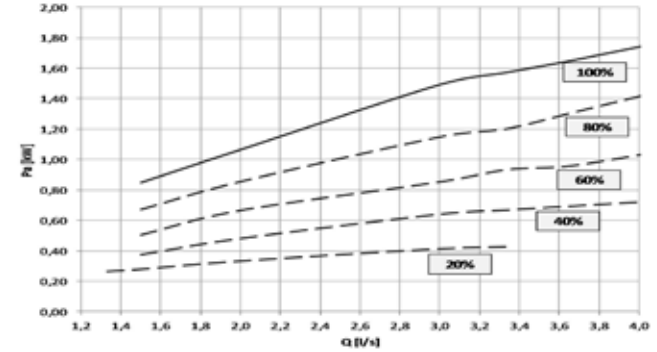

Q = Water flow rate [l/s] Pa = Electrical power draw [kW]

Cold side water diagram

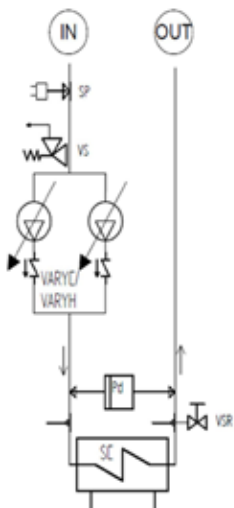

- IN = Cold side inlet
- OUT = Cold side outlet
- SP = Circuit charging pressure switch, calibrated to 0.7 bar
- VS = Safety valve calibrated to 6 bar
- VARYC = Hydronic unit VARYFLOW + cold side
- PD = Differential pressure switch
- VSR = Relief valve
- SC = Plate heat exchangers

(segue)

Unit with VARYFLOW + (VARYC)

Available pressure Size 19.2 -22.2

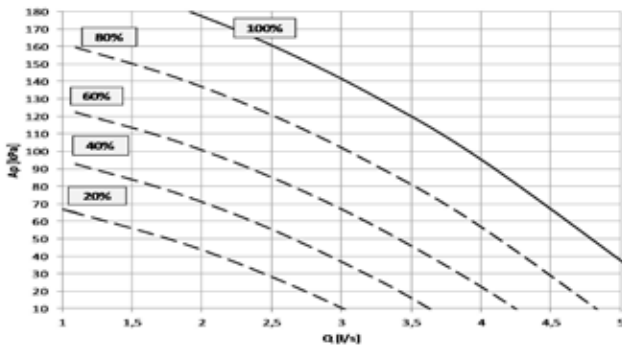

Q = Water flow rate [l/s] Ap = Pressure head, available to the unit fittings [kPa]

Absorption curves Size 19.2 -22.2

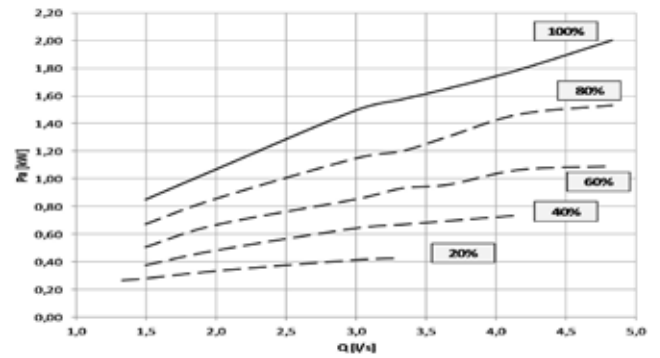

Q = Water flow rate [l/s] Pa = Electrical power draw [kW]

Available pressure Size 27.2

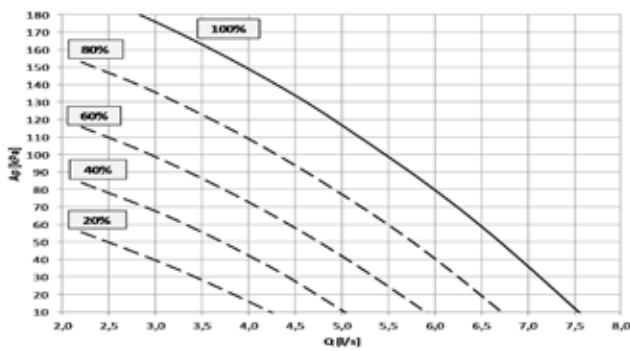

Q = Water flow rate [l/s] Ap = Pressure head, available to the unit fittings [kPa]

Absorption curves Size 27.2

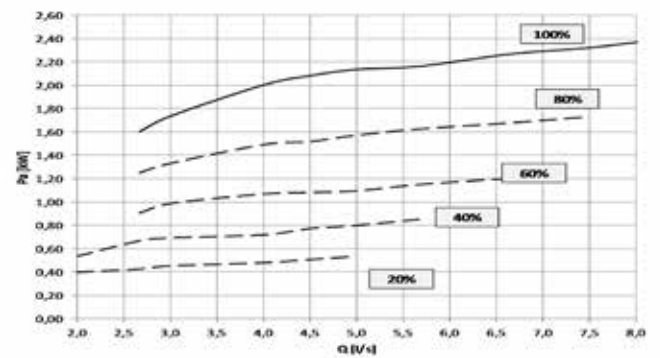

Q = Water flow rate [l/s] Pa = Electrical power draw [kW]

Available pressure Size 35.2

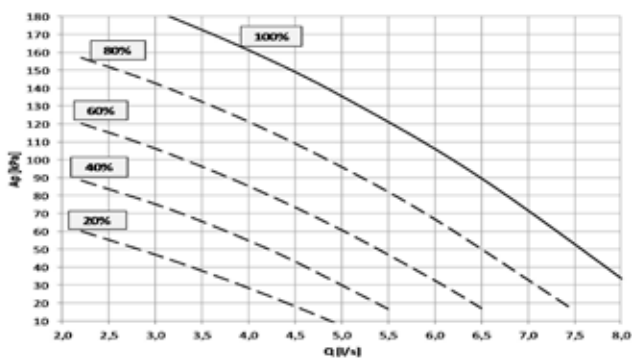

Q = Water flow rate [l/s] Ap = Pressure head, available to the unit fittings [kPa]

Absorption curves Size 35.2

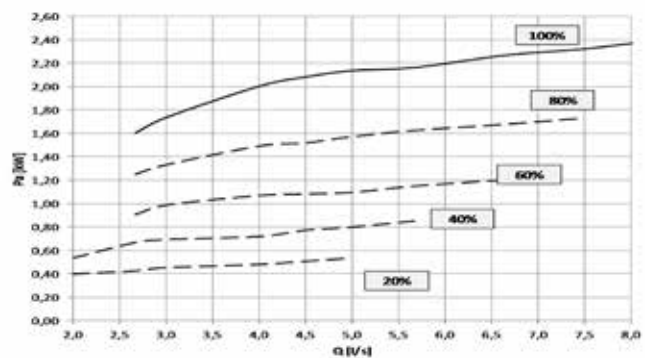

Q = Water flow rate [l/s] Pa = Electrical power draw [kW]

Available pressure Size 40.2

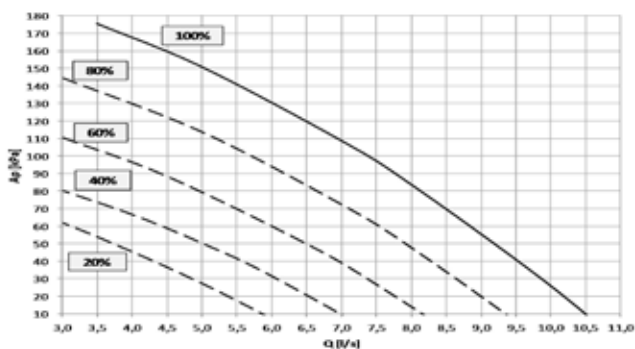

Q = Water flow rate [l/s] Ap = Pressure head, available to the unit fittings [kPa]

Absorption curves Size 40.2

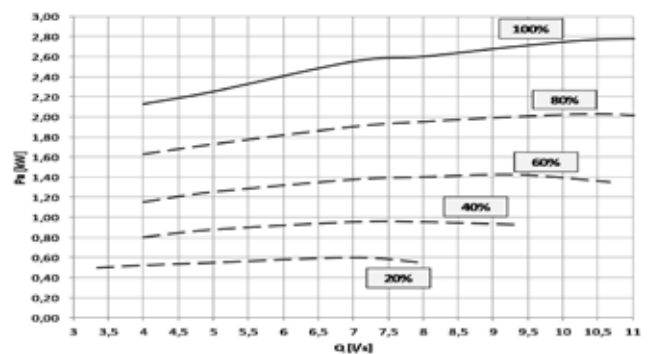

Q = Water flow rate [l/s] Pa = Electrical power draw [kW]

Configurations

Unit with VARYFLOW + (VARYC)

Available pressure Size 45.2

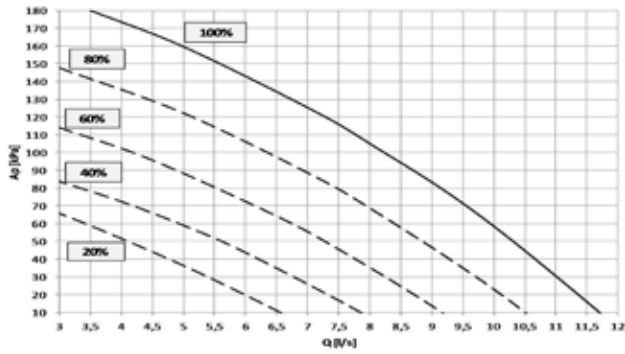

Q = Water flow rate [l/s] Ap = Pressure head, available to the unit fittings [kPa]

Absorption curves Size 45.2

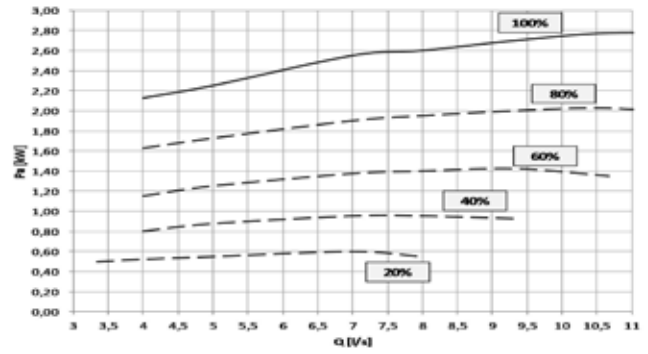

Q = Water flow rate [l/s] Pa = Electrical power draw [kW]

Available pressure Size 55.2

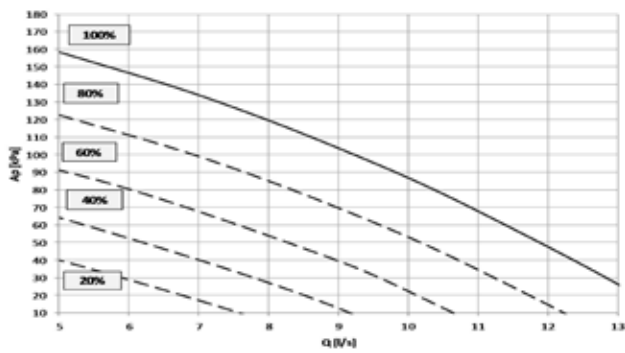

Q = Water flow rate [l/s] Ap = Pressure head, available to the unit fittings [kPa]

Absorption curves Size 55.2

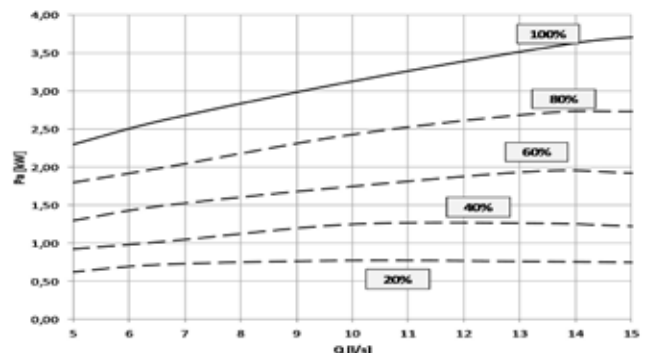

Q = Water flow rate [l/s] Pa = Electrical power draw [kW]

Available pressure Size 60.2

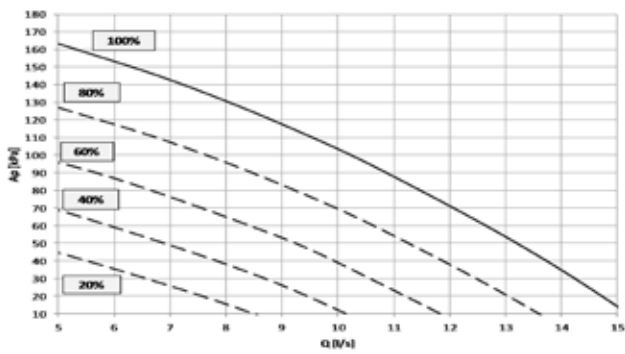

Q = Water flow rate [l/s] Ap = Pressure head, available to the unit fittings [kPa]

Absorption curves Size 60.2

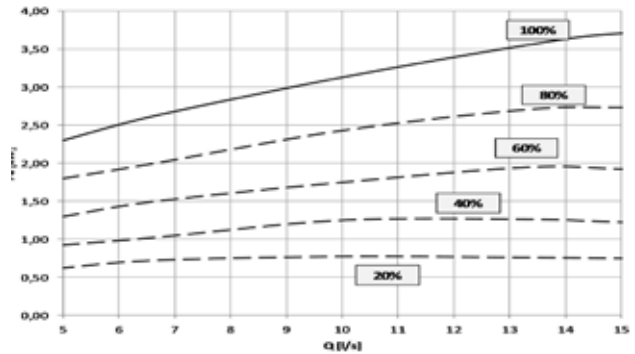

Q = Water flow rate [l/s] Pa = Electrical power draw [kW]

Available pressure Size 70.2

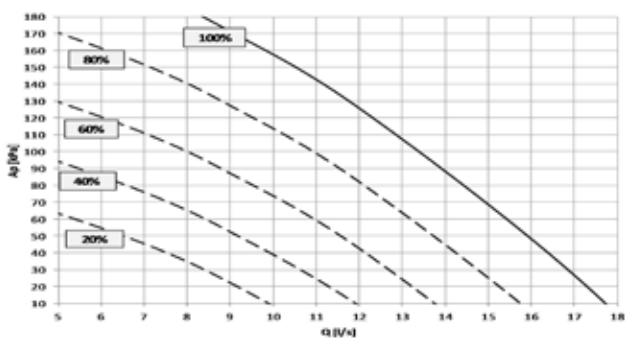

Q = Water flow rate [l/s] Ap = Pressure head, available to the unit fittings [kPa]

Absorption curves Size 70.2

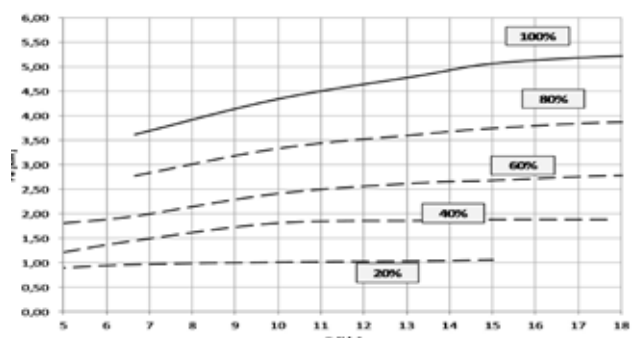

Q = Water flow rate [l/s] Pa = Electrical power draw [kW]

Unit with VARYFLOW + (VARYC)

Available pressure Size 80.2

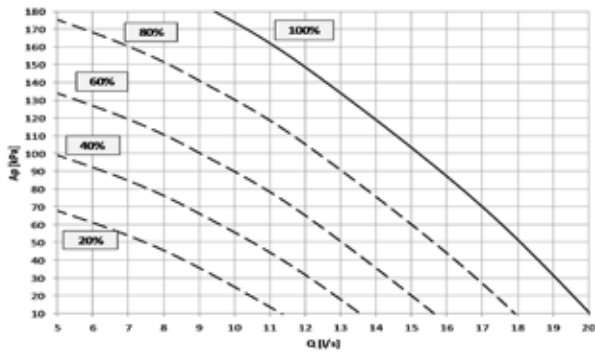

Q = Water flow rate [l/s] Ap = Pressure head, available to the unit fittings [kPa]

Absorption curves Size 80.2

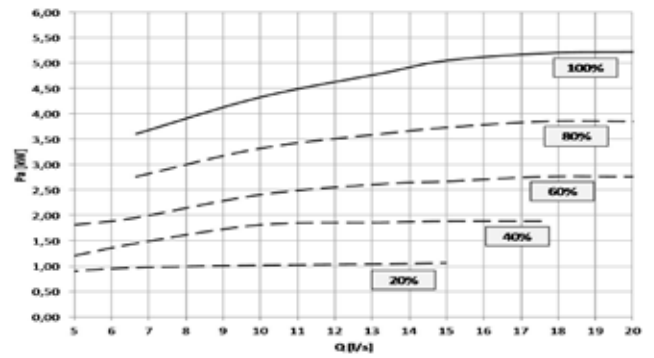

Q = Water flow rate [l/s] Pa = Electrical power draw [kW]

Available pressure Size 100.2 - 120.2

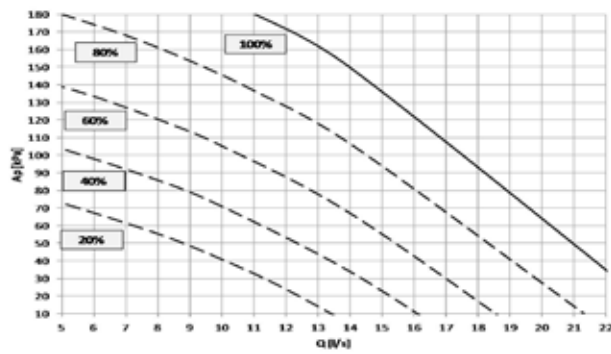

Q = Water flow rate [l/s] Ap = Pressure head, available to the unit fittings [kPa]

Absorption curves Size 100.2 - 120.2

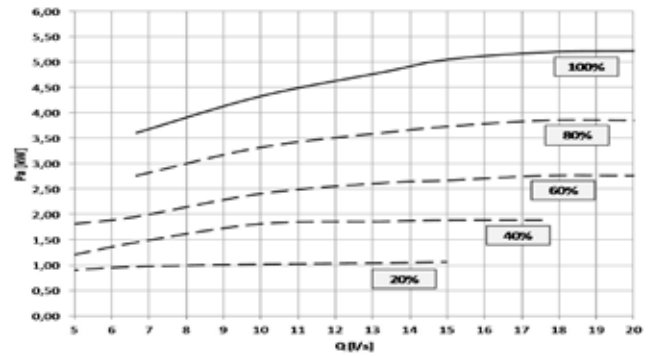

Q = Water flow rate [l/s] Pa = Electrical power draw [kW]

Configurations

Cold side hydronic unit

Unit with 3-way modulating valve (VS3MC)

Configuration with one cold side 3-way modulating valve and components as described on the water diagram key.

All water fittings are Victaulic type.

The 3-way modulating valve connects the cold side exchanger inlet and outlet, thus bypassing the exchanger and reducing the flow of water inside it, while keeping the machine's delivery flow constant.

The valve modulation is managed by a 0-10V signal generated by the unit electronic control.

Available only for the size from 12.2 to 80.2.

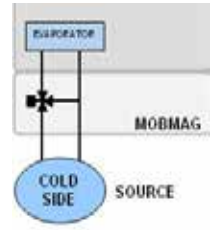

Cold side 3-way modulating valve pressure drops

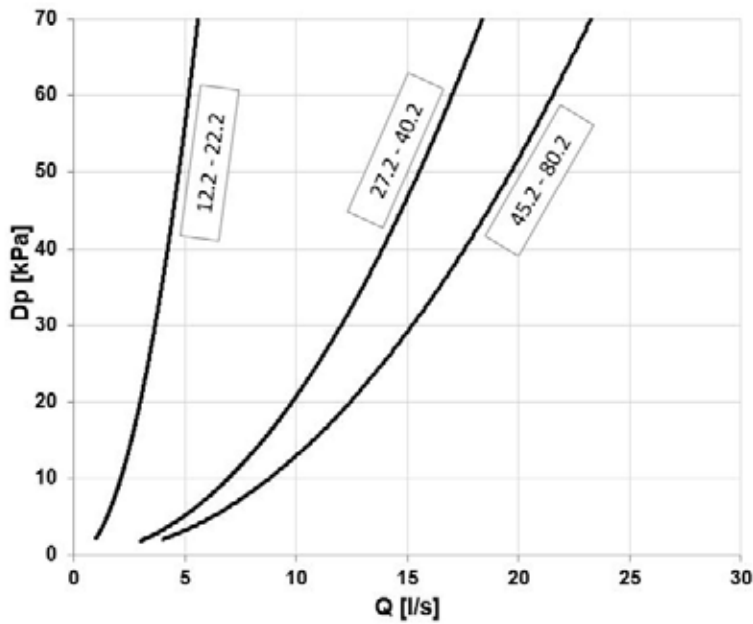

The pressure drops on the water side are calculated by considering an average water temperature at 7°C.

Q = Water flow rate [l/s]
DP = Pressure drops [kPa]

Cold side water diagram

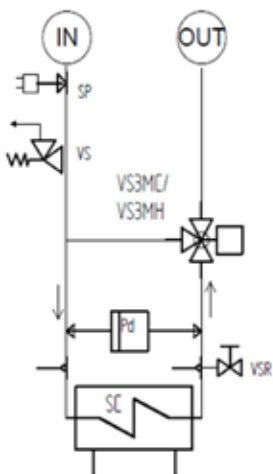

- IN = Cold side inlet
- OUT = Cold side outlet
- SP = Circuit charging pressure switch, calibrated to 0.7 bar
- VS = Safety valve calibrated to 6 bar
- VS3MC = Hydronic unit with cold side 3-way modulating valve
- PD = Differential pressure switch
- VSR = Relief valve
- SC = Plate heat exchangers

Cold side hydronic unit

Unit with 2-way modulating valve (VS2MC)

Configuration with one cold side 2-way modulating valve and components as described on the water diagram key.

All water fittings are Victaulic type.

The 2-way modulating valve, installed on the cold side exchanger inlet, modulates the water flow in response to a 0-10 V signal from the unit's controller.

Available only for the size from 12.2 to 80.2.

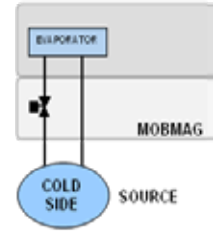

Cold side 2-way modulating valve pressure drops

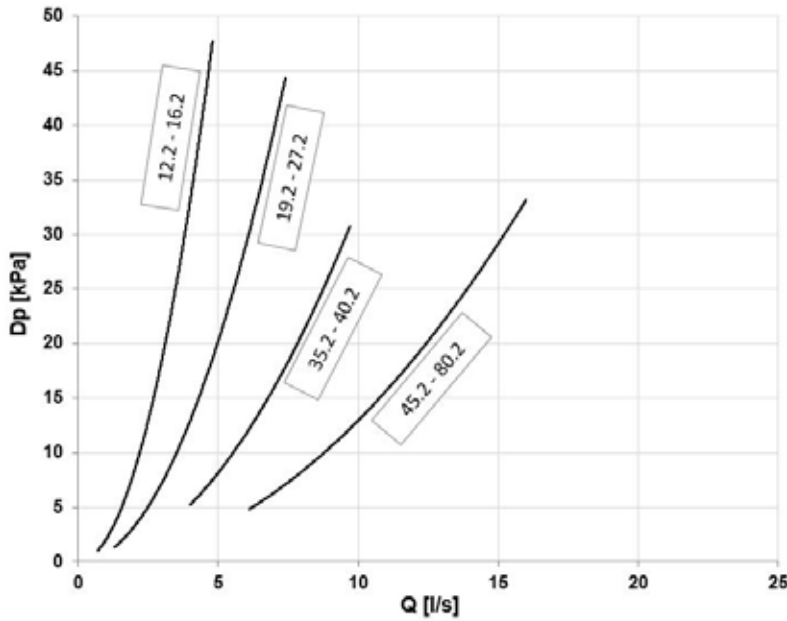

The pressure drops on the water side are calculated by considering an average water temperature at 7°C.

Q = Water flow rate [l/s]
DP = Pressure drops [kPa]

Cold side water diagram

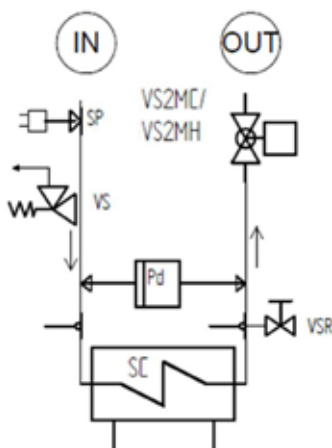

- IN = Cold side inlet
- OUT = Cold side outlet
- SP = Circuit charging pressure switch, calibrated to 0.7 bar
- VS = Safety valve calibrated to 6 bar
- VS2MC = Hydronic unit with cold side 2-way modulating valve
- PD = Differential pressure switch
- VSR = Relief valve
- SC = Plate heat exchangers

Configurations

Cold side hydronic unit

Unit with partial energy recovery (D)

Configuration with one recovery side brazed stainless steel (316 AISI) plate exchanger, and components per the legend of the enclosed plumbing circuit diagram. All water fittings are Victaulic type.

This configuration also permits free hot water production only during the chiller cycle, thanks to partial recovery of condensation heat which would otherwise be dissipated by the hot side heat exchanger.

It is possible to recovery about 1/4 of the unit rejected heating capacity equal to the sum of the cooling capacity and the compressor power input.

If cold water production is not requested, the unit can not produce hot water.

Option available only for the size from 12.2 to 80.2.

The heating capacity request is made by the digital contact enabling, that activates the pump recovery side (outside the unit).

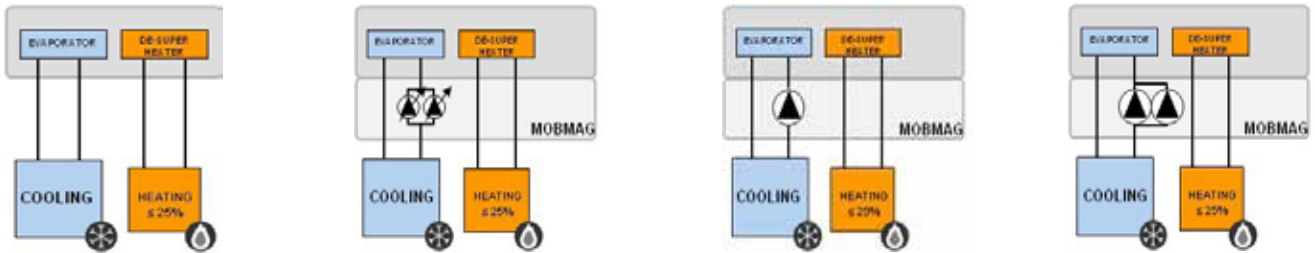

Desuperheater pressure drops

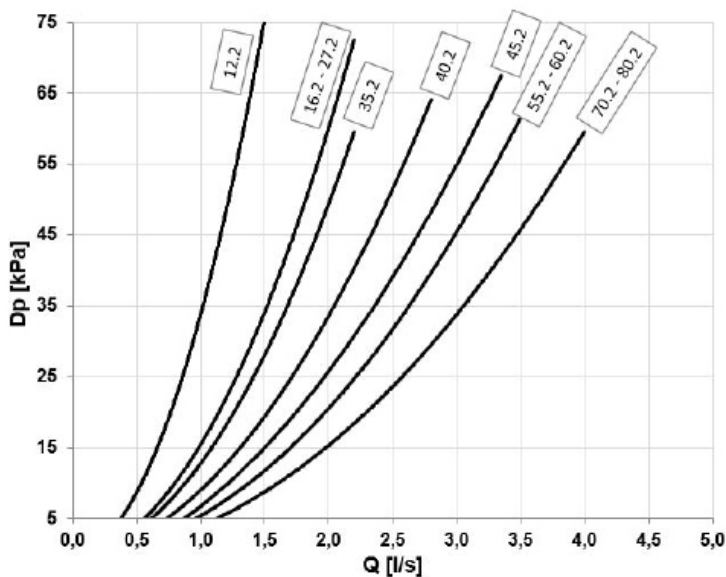

The pressure drops on the water side are calculated by considering an average water temperature at 7°C.

Q = Water flow rate [l/s]
DP = Pressure drops [kPa]

Partial recovery heating capacity

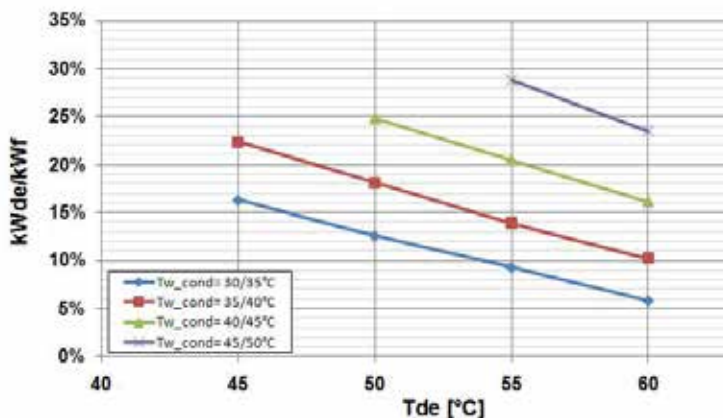

kWde/kWf = Potenza termica/Potenzialità frigorifera [%]
Tde [°C] = Temperatura uscita acqua scambiatore recupero (ΔT=5°C)
Temperatura uscita acqua scambiatore utilizzo = 7°C

Recovery side water diagram

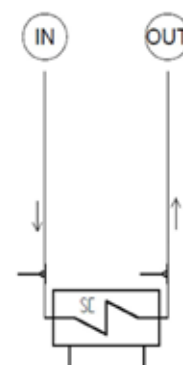

IN = Ingresso lato recupero
OUT = Uscita lato recupero
SC = Scambiatori di calore a piastre

Hot side hydronic unit

Standard unit (-)

Configuration without hydronic assembly, equipped with components as described on the water diagram key.

All water fittings are Victaulic type.

It is possible to control an external pump by an on/off or 0-10V signal.

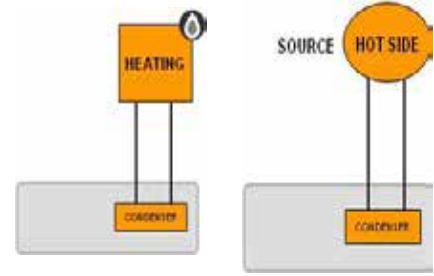

Hot side exchanger pressure drop curves

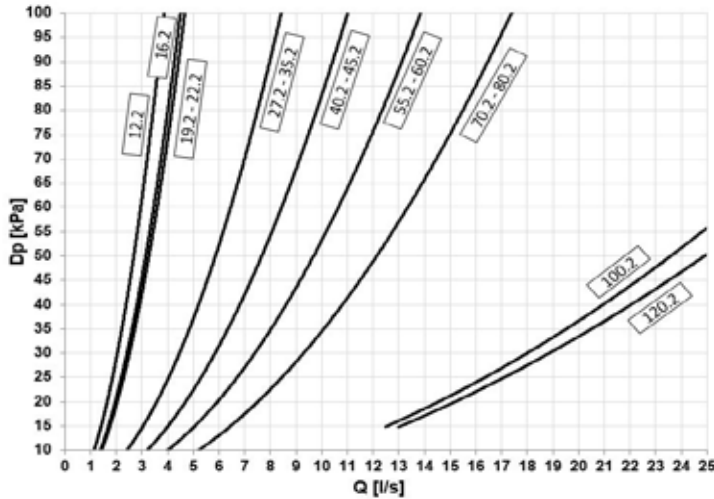

The pressure drops on the water side are calculated by considering an average water temperature at 7°C.

Q = Water flow rate [l/s]
DP = Pressure drops [kPa]

To the hot side exchanger's pressure drop we must add the pressure drop of the steel mesh filter installed on the water intake line. This device is essential to the unit's proper operation, and is available as accessory IFWX.

Admissible hot side water flows

Min. (Qmin) and max. (Qmax) water flow-rates admissibles for the correct unit operation.

GRANDEZZE	12.2	16.2	19.2	22.2	27.2	35.2	40.2	45.2	55.2	60.2	70.2	80.2	100.2	120.2	
Lato utilizzo	Qmin	1,1	1,4	1,4	1,4	2,4	1,9	3,2	3,2	3,9	3,8	5,4	5,4	12,5	13,2
	Qmax	4,2	4,8	4,9	5,3	8,8	9,3	11,4	12,2	15,0	15,4	18,3	19,0	28,0	29,0

Water diagram

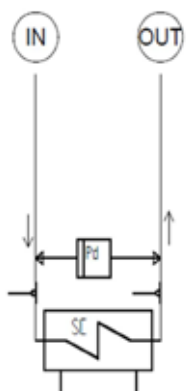

IN = Hot side inlet
OUT = Hot side outlet
PD = Differential pressure switch
SC = Plate heat exchangers

Configurations

Hot side hydronic unit

Unit with VARYFLOW + (VARYH)

Configuration with 2 centrifugal electric pumps arranged in parallel and controlled by inverter, with housing and impeller made with AISI 304 stainless steel, and components as described on the water diagram key. All water fittings are Victaulic type.

The electric pumps are equipped with three-phase electric motor with IP55-protection and complete with thermoformed insulated casing.

The control, modulates the water flow-rate keeping constant the delta T. If the water temperature is in critical conditions, it allows to extend the unit operating ranges guaranteeing its operating, automatically reducing the water flow-rate. In the event of one of the two pumps is temporarily unavailable, it guarantees about the 80% of the nominal flow-rate.

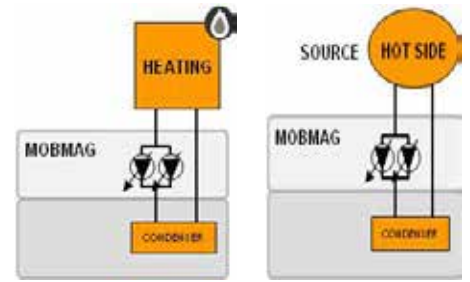

Available pressure Size 12.2

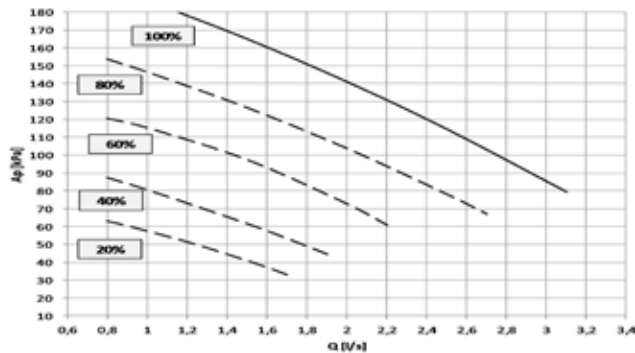

Q = Water flow rate [l/s] Ap = Pressure head, available to the unit fittings [kPa]

Absorption curves Size 12.2

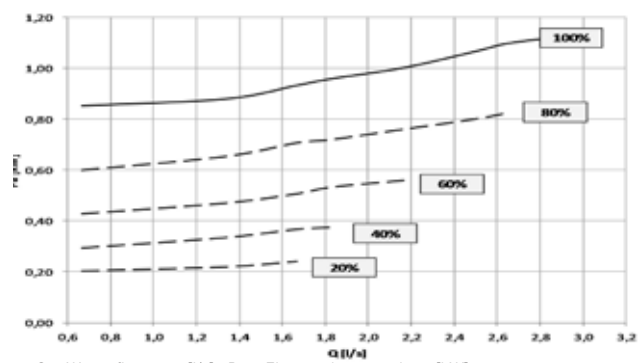

Q = Water flow rate [l/s] Pa = Electrical power draw [kW]

Hot side water diagram

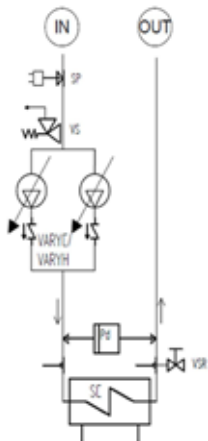

- IN = Hot side inlet
- OUT = Hot side outlet
- SP = Circuit charging pressure switch, calibrated to 0.7 bar
- VS = Safety valve calibrated to 6 bar
- VARYH = Hydronic unit VARYFLOW + hot side
- PD = Differential pressure switch
- VSR = Relief valve
- SC = Plate heat exchangers

Unit with VARYFLOW + (VARYH)

Available pressure Size 16.2

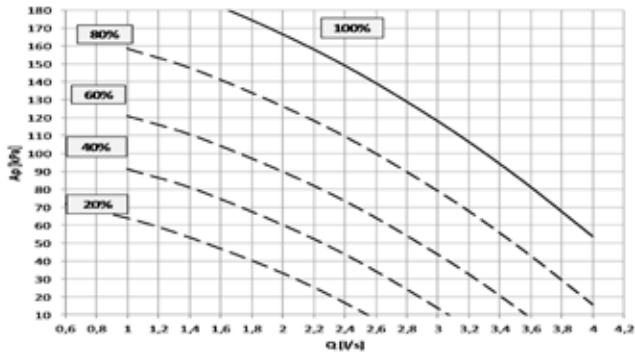

Q = Water flow rate [l/s] Ap = Pressure head, available to the unit fittings [kPa]

Absorption curves Size 16.2)

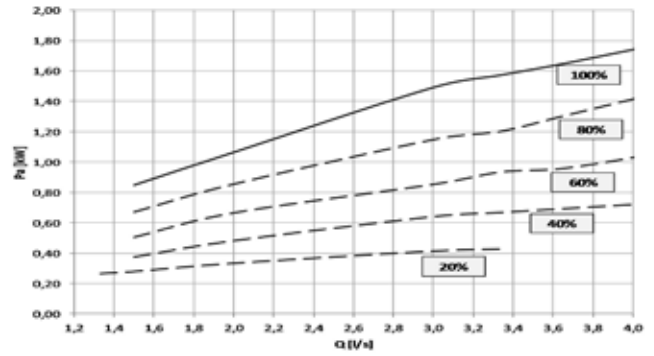

Q = Water flow rate [l/s] Pa = Electrical power draw [kW]

Available pressure Size 19.2 - 22.2

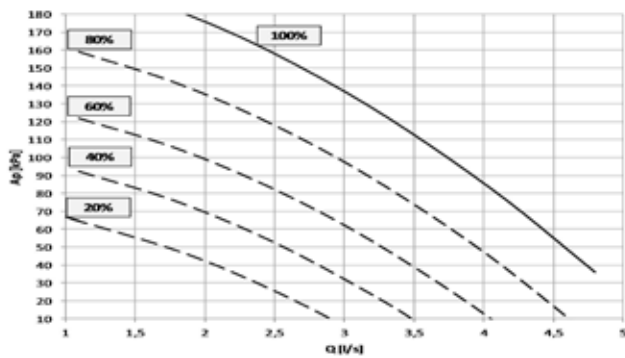

Q = Water flow rate [l/s] Ap = Pressure head, available to the unit fittings [kPa]

Absorption curves Size 19.2 - 22.2

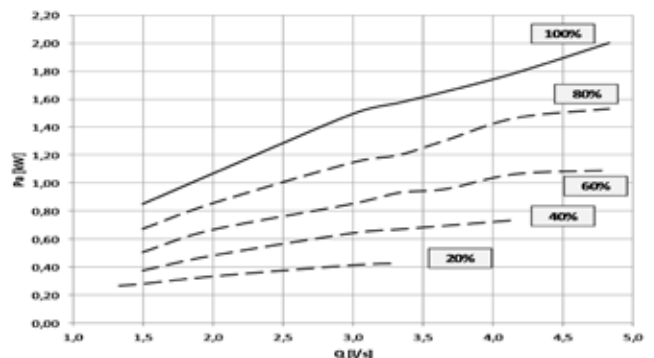

Q = Water flow rate [l/s] Pa = Electrical power draw [kW]

Available pressure Size 27.2 - 35.2

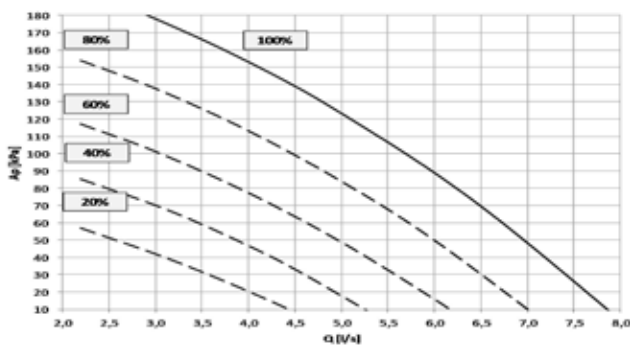

Q = Water flow rate [l/s] Ap = Pressure head, available to the unit fittings [kPa]

Absorption curves Size 27.2 - 35.2

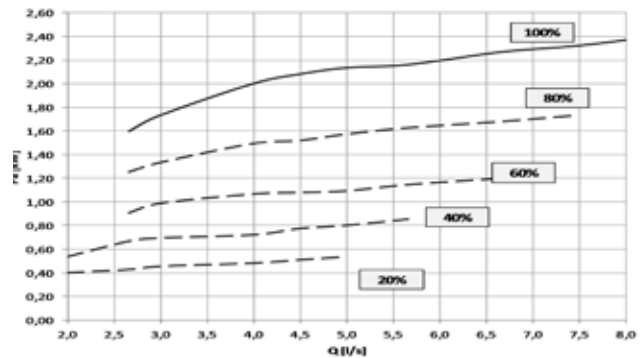

Q = Water flow rate [l/s] Pa = Electrical power draw [kW]

Available pressure Size 40.2 - 45.2

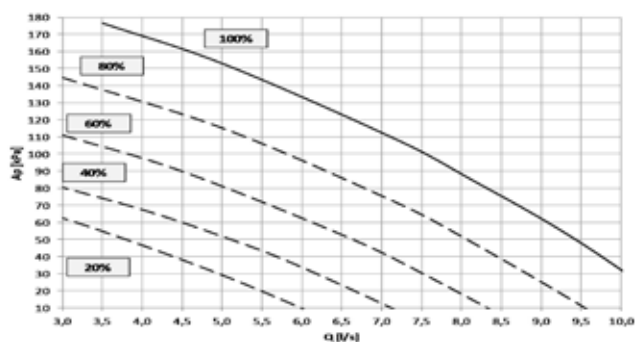

Q = Water flow rate [l/s] Ap = Pressure head, available to the unit fittings [kPa]

Absorption curves Size 40.2 - 45.2

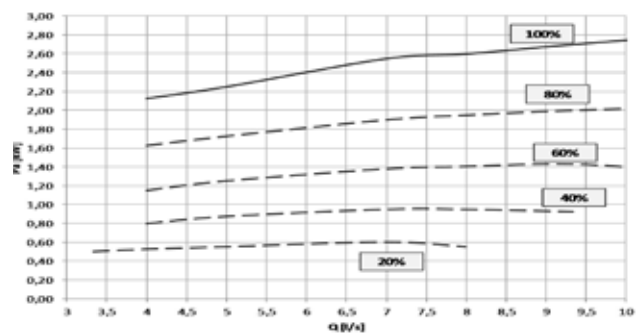

Q = Water flow rate [l/s] Pa = Electrical power draw [kW]

Configurations

Unit with VARYFLOW + (VARYH)

Available pressure Size 55.2 - 60.2

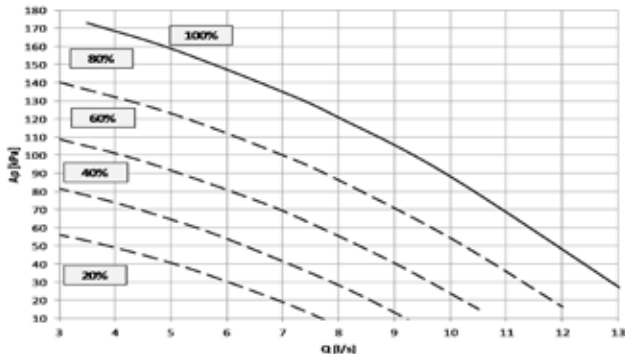

Q = Water flow rate [l/s] Ap = Pressure head, available to the unit fittings [kPa]

Absorption curves Size 55.2 - 60.2

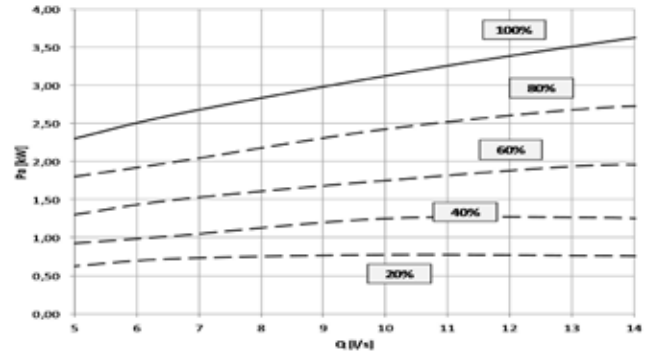

Q = Water flow rate [l/s] Pa = Electrical power draw [kW]

Available pressure Size 70.2 - 80.2

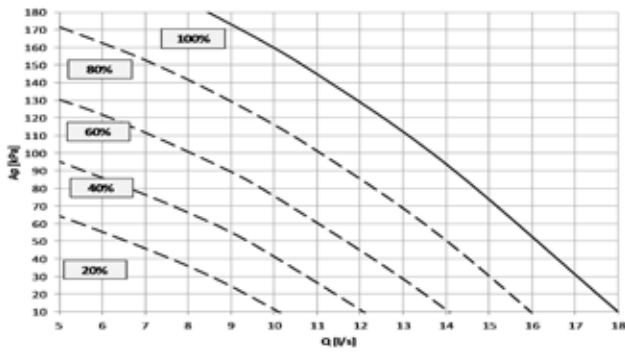

Q = Water flow rate [l/s] Ap = Pressure head, available to the unit fittings [kPa]

Absorption curves Size 70.2 - 80.2

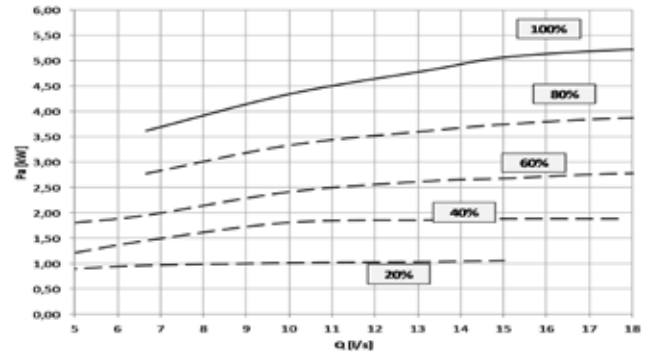

Q = Water flow rate [l/s] Pa = Electrical power draw [kW]

Available pressure Size. 100.2

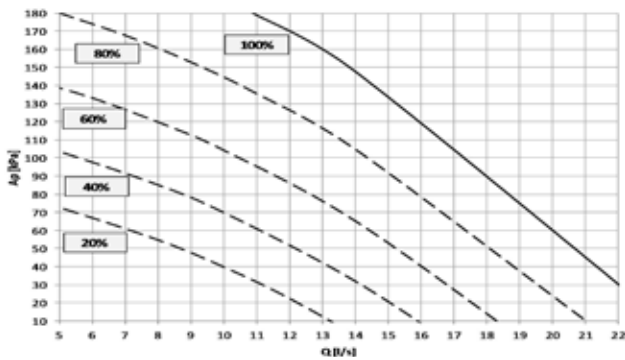

Q = Water flow rate [l/s] Ap = Pressure head, available to the unit fittings [kPa]

Absorption curves Size 100.2)

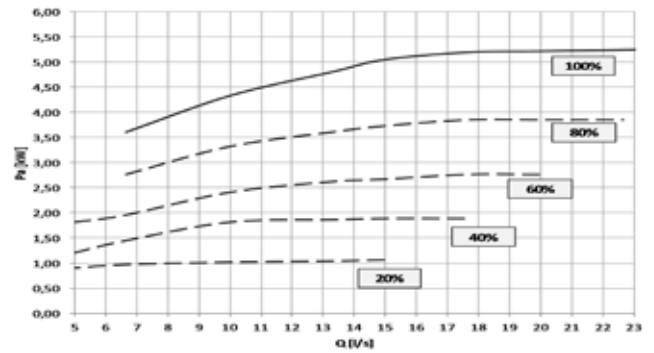

Q = Water flow rate [l/s] Pa = Electrical power draw [kW]

Available pressure Size 120.2

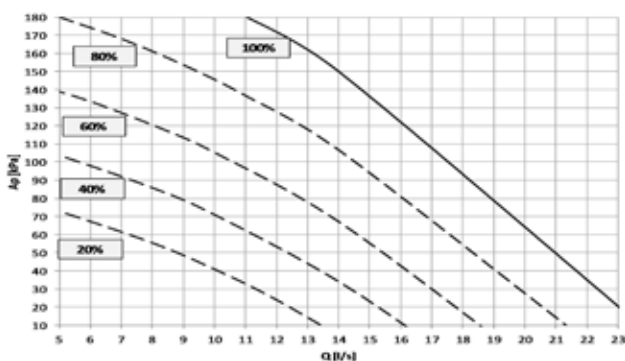

Q = Water flow rate [l/s] Ap = Pressure head, available to the unit fittings [kPa]

Absorption curves Size 120.2

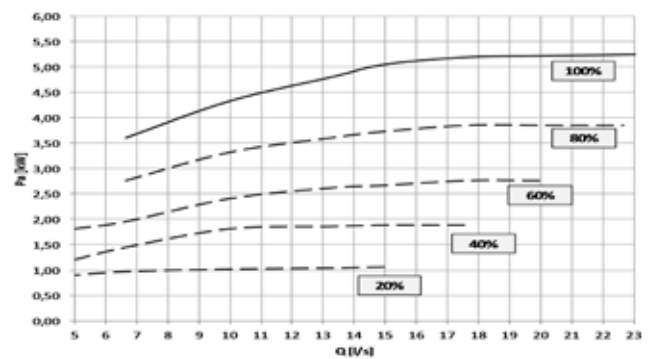

Q = Water flow rate [l/s] Pa = Electrical power draw [kW]

Hot side hydronic unit

Unit with 3-way modulating valve (VS3MH)

Configuration with 1 hot side 3-way modulating valve and components as described on the water diagram key. The 3-way modulating valve connects the hot side exchanger inlet and outlet, thus bypassing the exchanger and reducing the flow of water inside it, while keeping the machine's delivery flow constant. The valve modulation is managed by a 0-10V signal generated by the unit electronic control. Available only for the size from 12.2 to 80.2.

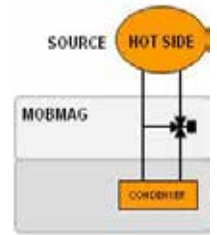

Hot side 3-way modulating valve pressure drops

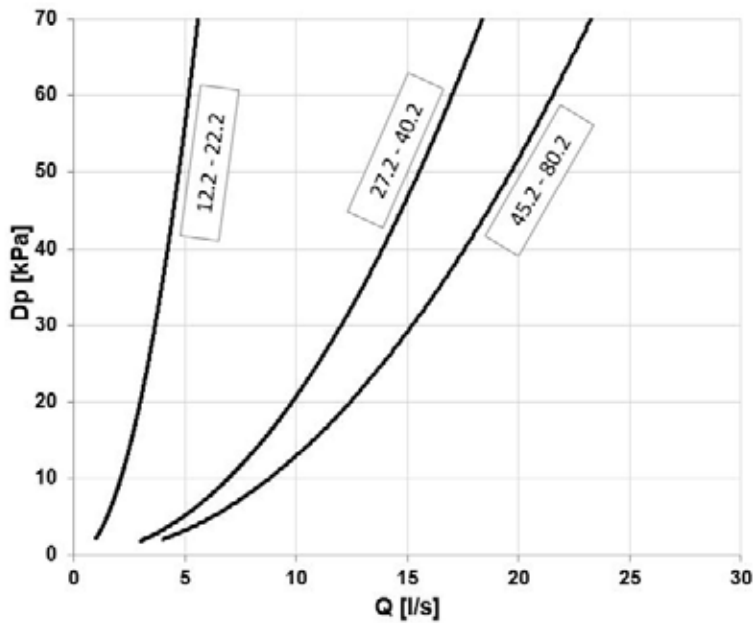

The pressure drops on the water side are calculated by considering an average water temperature at 7°C.

Q = Water flow rate [l/s]
DP = Pressure drops [kPa]

Hot side water diagram

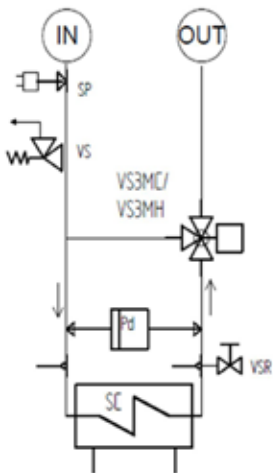

IN = Hot side inlet
 OUT = Hot side outlet
 SP = Circuit charging pressure switch, calibrated to 0.7 bar
 VS = Safety valve calibrated to 6 bar
 VS3MH = Hydronic unit with hot water side 3-way modulating valve
 PD = Differential pressure switch
 VSR = Relief valve
 SC = Plate heat exchangers

Configurations

Hot side hydronic unit

Unit with 2-way modulating valve (VS2MH)

Configuration with 1 hot side 2-way modulating valve and components as described on the water diagram key. All water fittings are Victaulic type. The 2-way modulating valve, installed on the hot side exchanger inlet, modulates the water flow in response to a 0-10 V signal from the unit's controller. Available only for the size from 12.2 to 80.2.

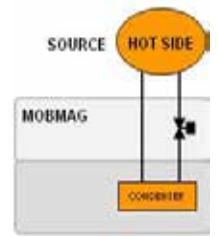

Hot side 2-way modulating valve pressure drops

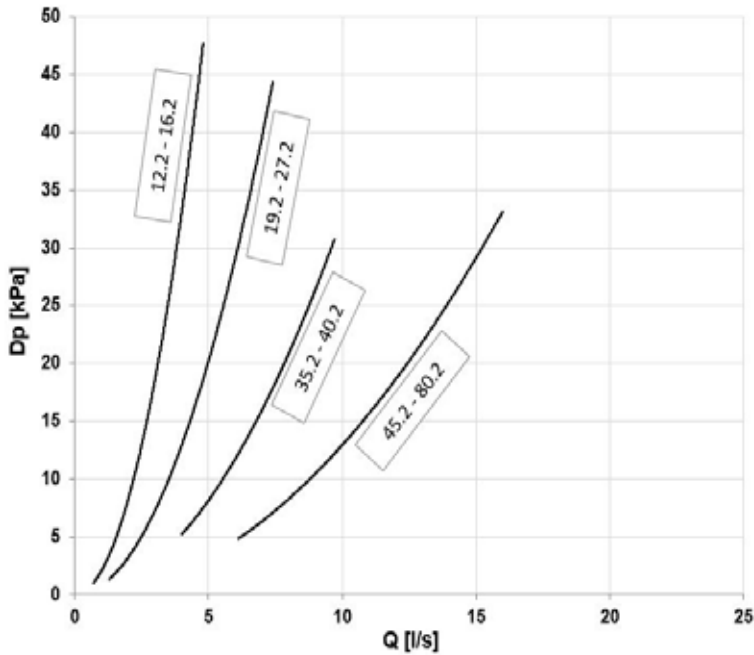

The pressure drops on the water side are calculated by considering an average water temperature at 7°C.

Q = Water flow rate [l/s]
DP = Pressure drops [kPa]

Hot side water diagram

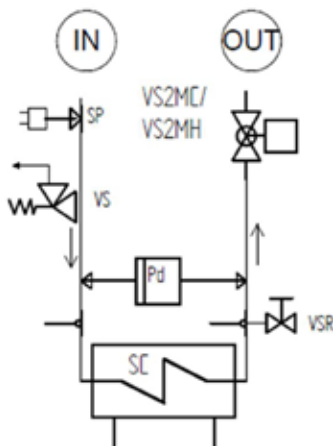

- IN = Hot side inlet
- OUT = Hot side outlet
- SP = Circuit charging pressure switch, calibrated to 0.7 bar
- VS = Safety valve calibrated to 6 bar
- VS2MH = Hydronic unit with hot side 2-way modulating valve
- PD = Differential pressure switch
- VSR = Relief valve
- SC = Plate heat exchangers

Heating only unit

Heating - OTH4 Operating conditions above 4°C

Size 12.2 40.2

SIZE	To (°C)	Cold side water outlet temperature (°C)											
		5		7		10		12		15		17	
		kWt	kWe	kWt	kWe	kWt	kWe	kWt	kWe	kWt	kWe	kWt	kWe
12.2	30	40,9	6,48	43,2	6,5	46,7	6,54	49,2	6,58	53,4*	6,65*	56,4*	6,70*
	35	40,4	7,23	42,6	7,26	46,0	7,31	48,5	7,35	52,6*	7,43*	56,0*	7,48*
	45	39,1	9,10	41,2	9,12	44,7	8,89	46,7	9,17	50,4*	9,23*	52,7*	9,27*
	55	36,8	11,7	38,6	11,7	41,4	11,7	43,4	11,7	46,6*	11,7*	48,6*	11,7*
	60	36,7	14,1	38,4	14,0	41,4	14,0	43,3	13,9	46,4*	13,9*	48,4*	13,8*
16.2	30	57,3	9,25	60,6	9,34	65,5	9,42	69,2	9,42	74,9	9,55	78,9	9,66
	35	56,5	10,1	59,7	10,2	64,5	10,3	68,1	10,4	73,7	10,5	77,6	10,7
	45	54,5	12,4	57,5	12,5	62,1	12,6	65,1	12,6	70,3	12,8	74,0	12,9
	55	51,1	15,8	53,6	15,8	57,5	15,8	60,4	15,8	64,7	15,9	67,9	16,0
	60	50,7	18,9	53,1	18,8	57,0	18,7	59,6	18,7	64,1	18,6	67,3	18,7
19.2	30	67,9	10,8	71,8	10,8	77,8	10,9	82,1	11,0	88,7	11,2	93,4	11,3
	35	67,0	11,8	70,8	11,8	76,6	11,9	80,7	12,0	87,0	12,1	91,8	12,3
	45	64,7	14,5	68,1	14,6	73,2	14,6	77,0	14,7	83,3	14,7	87,5	14,8
	55	59,9	18,5	62,8	18,5	67,3	18,5	70,7	18,5	76,0	18,6	79,8	18,6
	60	58,9	22,0	61,9	22,0	66,4	21,9	69,5	21,9	74,6	21,8	78,3	21,8
22.2	30	79,5	13,0	84,0	13,0	90,7	13,0	95,4	13,0	103	12,9	108	12,8
	35	78,8	14,4	83,1	14,4	89,8	14,5	94,4	14,6	102	14,6	107	14,6
	45	76,2	17,5	80,4	17,6	86,5	17,7	90,8	17,8	97,5	18,0	102	18,0
	55	70,7	21,7	74,1	21,8	79,7	21,9	83,8	21,5	89,6	22,2	93,9	22,3
	60	70,1	25,4	73,5	25,4	78,5	25,4	82,4	25,4	88,5	25,5	92,8	25,6
27.2	30	96,3	15,2	102	15,2	110	15,2	115	15,2	125	15,2	131	15,2
	35	95,1	16,7	100	16,8	108	16,9	114	16,9	123	17,0	129	17,0
	45	91,4	20,6	96,3	20,6	104	20,8	109	20,9	117	21,0	123	21,1
	55	84,1	25,7	88,3	25,8	95,1	25,9	99,3	26,0	107	26,2	112	26,3
	60	82,3	28,9	86,4	28,9	93,0	29,1	97,6	29,1	105	29,3	110	29,4
35.2	30	126	20,5	133	20,5	144	20,7	152	20,7	165	20,8	174	20,8
	35	124	22,4	131	22,6	142	22,8	150	23,0	162	23,1	171	23,2
	45	119	27,1	125	27,3	135	27,6	142	27,8	153	28,1	161	28,3
	55	110	33,7	115	33,9	124	34,2	130	34,5	140	34,8	147	35,0
	60	109	37,8	115	37,9	124	38,2	130	38,4	140	38,7	147	38,9
40.2	30	143	23,3	151	23,4	163	23,6	171	23,6	186	23,7	195	23,7
	35	141	25,5	148	25,7	161	25,9	169	26,0	183	26,2	192	26,3
	45	135	30,9	142	31,1	153	31,3	161	31,5	173	31,8	182	31,9
	55	125	38,1	131	38,3	141	38,6	148	38,8	159	39,1	166	39,3
	60	123	42,5	129	42,6	139	42,8	146	43,0	157	43,3	164	43,5

kWt = Heating capacity (kW)

kWe = Total Electrical power absorbed (compressor + Auxiliary Circuit)(kW)

To = Water outlet temperature hot side (°C)

The performances are referred to DeltaT=5°C on both the hot and cold sides

* Performance with modulating valve or control inverter pump cold side (optional configurations)

Performance

Heating only unit

Heating - OTH4 Operating conditions above 4°C

Size 45.2 - 120.2

SIZE	To (°C)	Cold side water outlet temperature (°C)											
		5		7		10		12		15		17	
		kWt	kWe	kWt	kWe	kWt	kWe	kWt	kWe	kWt	kWe	kWt	kWe
45.2	30	170	27,6	179	27,7	194	28,0	205	28,1	222	28,2	233	28,3
	35	167	30,1	176	30,3	191	30,7	201	30,9	218	31,2	229	31,3
	45	160	36,5	168	36,7	182	37,1	191	37,4	207	37,8	217	38,1
	55	148	45,3	155	45,5	166	45,9	175	46,2	188	46,6	197	47,0
	60	147	50,5	154	50,7	165	51,1	174	51,3	187	51,9	197	52,2
55.2	30	201	33,3	212	33,5	230	33,9	243	34,3	263	34,7	277	35,1
	35	197	36,1	208	36,3	225	36,8	238	37,1	258	37,6	271	38,0
	45	190	43,6	199	43,9	215	44,3	227	44,6	244	45,1	256	45,4
	55	176	54,2	185	54,5	198	54,8	208	55,1	224	55,6	234	56,0
	60	175	60,5	182	60,7	196	61,0	206	61,3	221	61,7	232	62,1
60.2	30	225	35,9	238	36,2	259	36,6	273	37,0	296	37,4	313	37,8
	35	220	40,3	232	40,6	252	41,1	267	41,6	289	42,2	305	42,6
	45	216	48,7	228	49,1	245	49,5	259	49,9	279	50,5	292	50,9
	55	202	60,7	212	61,0	227	61,4	238	61,8	256	62,5	268	62,9
	60	199	68,1	209	68,4	224	68,7	235	69,1	252	69,7	265	70,1
70.2	30	256	42,7	271	43,2	294	44,0	310	44,6	336	45,6	353	46,2
	35	252	46,0	267	46,5	289	47,3	305	47,9	330	48,8	347	49,5
	45	243	55,4	256	55,8	276	56,5	290	57,0	314	57,9	330	58,6
	55	225	68,4	236	68,8	253	69,4	266	69,9	286	70,9	300	71,5
	60	223	76,1	233	76,5	250	77,1	263	77,5	283	78,4	297	78,9
80.2	30	290	48,2	306	48,9	332	50,0	350	50,9	380	52,3	400	53,2
	35	285	52,0	301	52,7	326	53,8	344	54,7	372	56,0	391	56,8
	45	274	62,4	288	63,0	311	63,9	327	64,6	352	65,8	370	66,5
	55	253	76,5	266	77,1	285	78,0	299	78,6	323	79,7	339	80,4
	60	251	84,6	263	85,2	283	86,1	297	86,7	320	87,7	335	88,3
100.2	30	357	60,7	375	61,3	404	62,1	425	62,8	460	63,9	483	64,7
	35	352	66,0	370	66,6	398	67,5	419	68,2	452	69,3	475	70,0
	45	338	79,9	354	80,4	379	81,2	398	81,8	429	82,7	450	83,4
	55	312	99,6	326	100	350	101	367	101	393	102	411	102
	60	311	112	325	112	348	112	365	113	392	114	410	114
120.2	30	422	72,4	443	72,8	475	73,5	500	74,0	540	74,9	566	75,4
	35	416	79,1	436	79,6	469	80,4	492	80,9	531	81,8	556	82,4
	45	400	96,4	419	96,8	449	97,4	471	97,9	507	98,7	531	99,2
	55	370	122	386	122	412	122	434	122	463	123	483	123
	60	370	137	386	137	413	138	433	138	464	138	485	138

kWt = Heating capacity (kW)

kWe = Total Electrical power absorbed (compressor + Auxiliary Circuit)(kW)

To = Water outlet temperature hot side (°C)

The performances are referred to DeltaT=5°C on both the hot and cold sides

* Performance with modulating valve or control inverter pump cold side (optional configurations)

Cooling only unit

Cooling - OTH4 Operating conditions above 4°C

Size 12.2 40.2

SIZE	To (°C)	Hot side water outlet temperature (°C)									
		30		35		40		45		50	
		kWf	kWe	kWf	kWe	kWf	kWe	kWf	kWe	kWf	kWe
12.2	5	34,7	6,38	33,5	7,16	31,7	8,13	29,8	9,10	27,3	10,4
	7	37,0	6,40	35,6	7,18	33,8	8,15	31,8	9,12	29,2	10,4
	10	40,1	6,45	38,6	7,23	36,9	8,19	35,2	8,89	32,2	10,3
	12	42,3	6,55	40,7	7,35	38,8	8,30	36,5	9,26	33,7	10,5
	15	45,7	6,62	44,2	7,43	42,0	8,37	39,7	9,32	36,6	10,6
	18	49,7	6,70	48,0	7,52	45,6	8,45	43,2	9,39	39,9	10,6
16.2	5	48,5	9,24	46,7	10,0	44,3	11,3	41,7	12,4	38,3	14,1
	7	51,8	9,53	49,9	10,1	47,4	11,3	44,6	12,5	41,0	14,1
	10	56,2	9,53	54,1	10,2	51,4	11,4	48,7	12,6	44,8	14,2
	12	59,3	9,36	57,0	10,4	54,1	11,6	51,1	12,7	47,2	14,4
	15	64,7	9,52	62,2	10,5	59,1	11,7	55,7	12,9	51,5	14,5
	18	70,2	9,67	67,4	10,7	64,1	11,9	60,3	13,1	55,8	14,6
19.2	5	57,7	10,6	55,7	11,7	52,8	13,1	49,7	14,5	45,3	16,5
	7	61,6	10,6	59,4	11,7	56,5	13,1	53,2	14,6	48,5	16,5
	10	66,8	10,7	64,5	11,8	61,1	13,2	57,6	14,6	52,7	16,6
	12	70,2	10,9	67,9	12,0	64,3	13,4	60,7	14,8	55,7	16,8
	15	76,7	11,1	74,0	12,2	70,2	13,5	66,4	14,9	60,9	16,8
	18	83,2	11,3	80,2	12,3	76,1	13,6	72,0	15,0	66,2	16,9
22.2	5	66,9	13,0	64,5	14,4	61,2	16,0	57,3	17,7	52,6	19,9
	7	71,5	13,0	68,8	14,5	65,4	16,1	61,2	17,8	56,2	20,0
	10	77,2	13,0	74,6	14,6	70,8	16,3	66,8	18,0	61,2	20,1
	12	81,1	13,2	78,2	14,8	74,7	16,5	70,2	18,3	64,4	20,4
	15	88,4	13,1	85,1	14,9	81,3	16,6	76,6	18,4	70,5	20,6
	18	95,6	13,0	92,0	14,9	87,9	16,7	82,9	18,6	76,5	20,8
27.2	5	82,2	15,0	79,0	16,7	75,1	18,7	70,3	20,8	64,1	23,4
	7	87,4	15,1	84,2	16,8	80,1	18,8	75,1	20,9	68,5	23,5
	10	94,6	15,1	91,2	16,9	86,7	18,9	81,5	21,0	74,7	23,6
	12	99,7	15,1	95,8	16,9	91,5	19,0	85,8	21,1	78,5	23,7
	15	108	15,1	104	17,0	99,7	19,0	93,5	21,2	85,8	23,9
	18	117	15,0	113	17,0	108	19,1	101	21,4	93,1	24,0
35.2	5	107	20,1	102	22,2	97,2	24,5	90,7	27,1	83,0	30,4
	7	114	20,2	109	22,4	104	24,7	96,7	27,3	88,6	30,6
	10	124	20,3	118	22,6	113	25,0	106	27,6	96,9	30,9
	12	131	20,6	125	23,0	119	25,4	111	28,1	102	31,5
	15	143	20,6	137	23,1	130	25,6	121	28,4	111	31,8
	18	154	20,7	148	23,3	141	25,8	131	28,7	121	32,1
40.2	5	121	22,9	116	25,3	110	28,0	103	30,9	94,8	34,5
	7	129	23,0	124	25,4	118	28,2	110	31,1	101	34,7
	10	139	23,1	134	25,6	127	28,4	120	31,3	110	35
	12	147	23,4	141	26,0	135	28,8	126	31,8	116	35,5
	15	160	23,5	154	26,1	147	29,0	137	32,1	127	35,8
	18	173	23,5	167	26,3	159	29,2	149	32,4	137	36,1

kWf = Cooling capacity in kW

kWe = Total Electrical power absorbed (compressor + Auxiliary Circuit)(kW)

To = Water outlet temperature cold side (°C)

The performances are referred to DeltaT=5°C on both the hot and cold sides

Performance

Cooling only unit

Cooling - OOTH4 Operating conditions above 4°C

Size 45.2 - 120.2

SIZE	To (°C)	Hot side water outlet temperature (°C)									
		30		35		40		45		50	
		kWf	kWe	kWf	kWe	kWf	kWe	kWf	kWe	kWf	kWe
45.2	5	144	27,0	138	29,8	131	33,0	123	36,5	112	40,9
	7	153	27,2	147	30,0	140	33,2	131	36,7	120	41,1
	10	166	27,4	160	30,4	152	33,5	142	37,1	130	41,5
	12	175	27,8	169	30,9	160	34,1	150	37,8	138	42,2
	15	191	28,0	184	31,2	175	34,4	164	38,2	150	42,6
	18	207	28,2	199	31,4	190	34,8	177	38,6	163	43,1
55.2	5	169	32,5	162	35,7	154	39,5	145	43,6	133	48,9
	7	181	32,8	173	36,0	165	39,7	154	43,9	142	49,2
	10	195	33,2	188	36,4	179	40,1	168	44,3	154	49,6
	12	207	33,9	199	37,1	189	40,8	177	45,0	163	50,3
	15	226	34,4	217	37,6	206	41,3	193	45,5	178	50,9
	18	244	34,9	235	38,1	224	41,7	209	46,0	193	51,4
60.2	5	193	36,7	185	40,3	175	44,5	164	49,3	150	55,3
	7	206	37,0	197	40,6	188	44,8	175	49,6	160	55,6
	10	223	37,6	214	41,2	203	45,3	190	50,0	174	56,1
	12	235	38,3	225	42,0	214	46,1	200	51,0	184	57,1
	15	257	38,9	246	42,6	234	46,7	219	51,6	201	57,7
	18	279	39,5	267	43,2	254	47,3	237	52,2	219	58,4
70.2	5	216	41,7	208	45,6	198	50,3	186	55,4	171	61,9
	7	231	42,2	222	46,0	212	50,7	198	55,8	182	62,3
	10	250	42,9	241	46,8	229	51,4	216	56,5	198	63,0
	12	264	44,0	254	47,9	241	52,4	226	57,6	208	64,1
	15	287	45,0	277	48,9	263	53,3	247	58,5	227	65,0
	18	311	45,9	299	49,8	285	54,2	267	59,4	246	65,9
80.2	5	244	47,2	235	51,5	223	56,7	210	62,4	192	69,4
	7	259	47,8	250	52,2	238	57,3	223	63,0	205	70,0
	10	283	49,0	272	53,3	259	58,2	242	63,9	223	70,9
	12	297	50,4	286	54,7	273	59,5	255	65,3	235	72,3
	15	323	51,8	311	56,0	297	60,7	278	66,4	256	73,4
	18	349	53,2	337	57,4	321	61,9	301	67,6	278	74,5
100.2	5	300	60,1	289	66,0	275	72,4	257	79,9	235	89,8
	7	319	60,7	306	66,6	291	72,9	273	80,4	249	90,2
	10	343	61,7	331	67,5	315	73,8	295	81,2	271	90,9
	12	360	63,1	347	68,9	330	75,2	310	82,6	285	92,4
	15	392	64,2	377	70,0	360	76,3	337	83,6	310	93,3
	18	423	65,4	408	71,2	389	77,4	365	84,6	336	94,2
120.2	5	351	72,3	337	79,5	321	87,3	300	97,0	273	110
	7	371	72,8	357	80,0	340	87,8	318	97,3	290	110
	10	401	73,5	388	80,8	370	88,6	345	97,9	315	110
	12	421	74,8	407	82,2	387	90,0	362	99,4	333	112
	15	458	75,7	441	83,2	421	90,9	395	100	363	113
	18	494	76,6	476	84,1	455	91,8	427	101	393	113

kWf = Cooling capacity in kW

kWe = Total Electrical power absorbed (compressor + Auxiliary Circuit)(kW)

To = Water outlet temperature cold side (°C)

The performances are referred to DeltaT=5°C on both the hot and cold sides

Heating only unit

Heating - OTL4 - Operating conditions below 4°C

Size 12.2 - 40.2

SIZE	To (°C)	Cold side water outlet temperature (°C)											
		-6		-3		-1		0		1		3	
		kWt	kWe	kWt	kWe	kWt	kWe	kWt	kWe	kWt	kWe	kWt	kWe
12.2	30	30,0	6,34	32,5	6,35	34,4	6,36	35,5	6,36	36,5	6,37	38,6	6,38
	35	29,8	7,07	32,2	7,08	34,1	7,09	35,1	7,10	36,1	7,10	38,1	7,12
	45	29,7	9,05	31,9	9,10	33,6	9,08	34,5	9,08	35,5	9,08	37,4	9,08
	50	-	-	31,1	10,5	32,8	10,5	33,6	10,4	34,5	10,4	36,3	10,4
	55	-	-	-	-	-	-	32,7	11,8	33,5	11,8	35,2	11,8
16.2	30	42,3	8,89	46,0	8,89	48,6	8,90	50,1	8,91	51,6	8,92	54,7	8,95
	35	41,9	9,83	45,4	9,85	48,0	9,86	49,5	9,88	50,9	9,89	53,9	9,93
	45	41,3	12,5	44,7	12,4	47,1	12,4	48,4	12,4	49,7	12,4	52,5	12,5
	50	-	-	43,4	14,2	45,7	14,2	46,9	14,2	48,2	14,2	50,7	14,2
	55	-	-	-	-	-	-	-	-	46,6	15,9	49,0	15,9
19.2	30	50,1	10,3	54,4	10,4	57,4	10,4	59,3	10,4	60,9	10,4	64,4	10,4
	35	49,5	11,4	53,8	11,5	56,7	11,5	58,5	11,5	60,1	11,5	63,5	11,6
	45	48,6	14,5	52,5	14,5	55,6	14,5	57,1	14,5	58,6	14,5	61,7	14,5
	50	47,1	16,6	50,8	16,5	53,6	16,5	55,1	16,5	56,6	16,5	59,5	16,5
	55	-	-	49,0	18,6	51,7	18,6	53,1	18,6	54,6	18,6	57,2	18,6
22.2	30	59,0	12,5	64,1	12,6	67,6	12,6	69,6	12,7	71,5	12,7	75,6	12,7
	35	58,5	13,7	63,5	13,9	67,0	14,0	68,9	14,0	70,7	14,0	74,7	14,1
	45	57,6	17,1	62,1	17,1	65,5	17,2	67,3	17,3	69,4	17,3	72,9	17,4
	50	56,1	19,4	60,3	19,4	63,5	19,4	65,2	19,5	67,0	19,5	70,3	19,6
	55	-	-	58,5	21,7	61,6	21,7	63,1	21,7	64,6	21,7	67,8	21,7
27.2	30	69,0	14,7	75,7	14,8	80,1	14,9	82,5	14,9	85,0	14,9	89,8	15,0
	35	68,4	16,1	75,0	16,2	79,4	16,3	81,7	16,4	84,1	16,4	88,8	16,5
	45	66,9	20,0	73,1	20,1	77,3	20,2	79,4	20,2	81,5	20,3	86,1	20,4
	50	64,8	22,7	70,7	22,7	74,5	22,8	76,5	22,8	78,6	22,9	82,8	23,0
	55	-	-	68,2	25,4	71,7	25,4	73,6	25,4	75,6	25,5	79,6	25,5
35.2	30	87,7	19,5	96,6	19,7	102	19,8	105	19,9	109	19,9	115	20,1
	35	86,7	21,2	95,3	21,4	101	21,6	104	21,7	107	21,7	113	21,9
	45	85,5	26,0	93,3	26,2	98,4	26,4	101	26,5	104	26,6	110	26,8
	50	82,8	29,4	90,5	29,6	95,4	29,7	97,9	29,8	101	29,9	106	30,1
	55	-	-	-	-	92,4	33,1	94,8	33,2	97,3	33,3	102	33,4
40.2	30	101	22,3	111	22,6	118	22,7	121	22,8	125	22,8	132	22,9
	35	101	24,3	110	24,5	116	24,7	120	24,8	123	24,9	130	25,0
	45	99	29,8	108	30,1	114	30,2	117	30,3	120	30,4	127	30,6
	50	95,8	33,5	105	33,7	110	33,9	113	34,0	116	34,0	122	34,2
	55	-	-	-	-	106	37,5	109	37,6	112	37,7	118	37,8

kWt = Heating capacity (kW)

kWe = Total Electrical power absorbed (compressor + Auxiliary Circuit)(kW)

To = Water outlet temperature hot side (°C)

The performances are referred to DeltaT=5°C on both the hot and cold sides

Data refer to operation with a mix of water and propylene glycol at 30% on the cold side

Performance

Heating only unit

Heating - OTL4 - Operating conditions below 4°C

Size 45.2 - 120.2

SIZE	To (°C)	Cold side water outlet temperature (°C)											
		-6		-3		-1		0		1		3	
		kWt	kWe	kWt	kWe	kWt	kWe	kWt	kWe	kWt	kWe	kWt	kWe
45.2	30	119	26,2	131	26,5	138	26,6	142	26,7	147	26,8	155	27,0
	35	118	28,6	129	28,9	137	29,0	141	29,1	145	29,2	153	29,4
	45	117	35,4	127	35,5	134	35,6	137	35,7	141	35,8	149	36,1
	50	114	39,9	123	40,0	130	40,1	133	40,2	137	40,3	144	40,5
	55	-	-	-	-	126	44,6	129	44,6	132	44,7	139	44,9
55.2	30	143	31,6	156	31,9	166	32,1	171	32,2	176	32,3	186	32,5
	35	142	34,4	155	34,7	164	34,9	168	35,0	173	35,1	183	35,3
	45	140	42,5	152	42,7	160	42,8	165	42,9	169	43,1	179	43,3
	50	-	-	148	48,0	156	48,1	159	48,2	164	48,3	173	48,5
	55	-	-	-	-	151	53,5	154	53,6	159	53,6	166	53,8
60.2	30	160	35,4	175	35,8	185	36,0	191	36,1	197	36,3	208	36,6
	35	159	38,7	173	39,0	183	39,2	188	39,3	194	39,5	205	39,8
	45	157	48,1	170	48,2	179	48,2	184	48,4	189	48,5	200	48,8
	50	-	-	166	54,3	174	54,4	179	54,5	184	54,6	193	54,8
	55	-	-	-	-	169	60,6	174	60,6	178	60,7	187	60,9
70.2	30	181	39,7	198	40,2	209	40,5	215	40,7	222	40,9	235	41,3
	35	180	43,2	196	43,7	207	44,0	213	44,2	219	44,4	231	44,8
	45	178	53,3	192	53,7	203	54,0	208	54,1	214	54,3	226	54,7
	50	-	-	187	60,1	197	60,4	202	60,6	208	60,8	218	61,2
	55	-	-	-	-	191	66,9	196	67,1	201	67,3	211	67,6
80.2	30	202	44,1	220	44,8	233	45,3	239	45,6	247	45,8	260	46,4
	35	200	48,0	218	48,7	231	49,2	236	49,5	243	49,7	257	50,2
	45	198	58,9	214	59,7	226	60,2	231	60,4	238	60,6	251	61,2
	50	-	-	208	66,6	219	67,1	224	67,4	230	67,6	242	68,2
	55	-	-	-	-	212	74,1	218	74,4	223	74,7	234	75,2
100.2	30	247	56,7	267	57,3	282	57,7	290	57,9	298	58,2	314	58,6
	35	245	61,5	265	62,1	279	62,6	288	62,8	295	63,0	311	63,5
	45	243	76,1	262	76,6	276	77,0	282	77,2	290	77,5	304	77,9
	50	-	-	254	86,5	267	86,9	273	87,1	281	87,3	295	87,7
	55	-	-	-	-	259	96,8	265	97,0	272	97,2	285	97,6
120.2	30	290	69,0	313	69,5	331	70,0	340	70,1	348	70,3	367	70,7
	35	289	74,9	312	75,5	329	76,0	337	76,2	346	76,4	365	76,9
	45	287	93,3	308	93,8	324	94,2	333	94,4	340	94,6	357	94,9
	50	-	-	299	107	314	107	323	107	330	107	346	108
	55	-	-	-	-	304	120	313	120	320	120	335	121

kWt = Heating capacity (kW)

kWe = Total Electrical power absorbed (compressor + Auxiliary Circuit)(kW)

To = Water outlet temperature hot side (°C)

The performances are referred to DeltaT=5°C on both the hot and cold sides

Data refer to operation with a mix of water and propylene glycol at 30% on the cold side

OTH4 and OTL4 version without hydronic unit

Size 12.2 - 22.2

DAA8P10 2_22 2 STD REV00

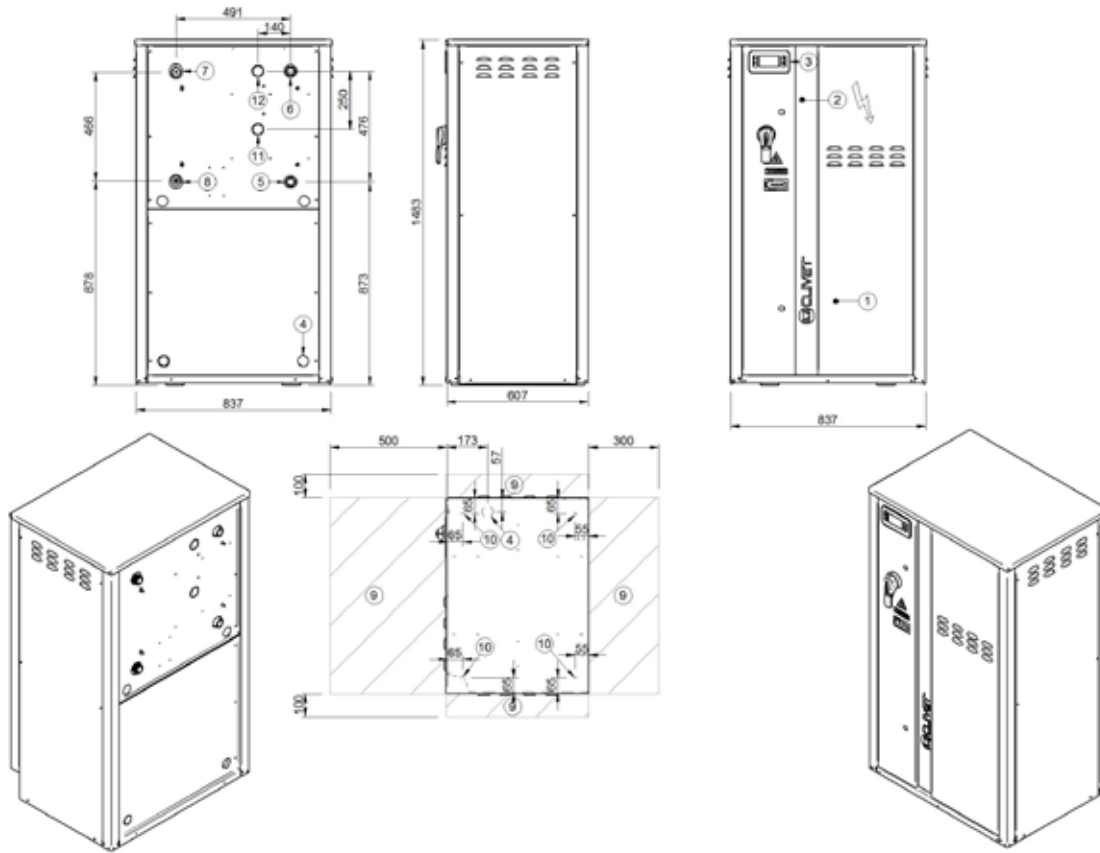

1. Compressor compartment
2. Electrical panel
3. Unit control keypad
4. Power input
5. Hot side water return (1" 1/4 GAS)
6. Hot side water supply (1" 1/4 GAS)
7. Cold side water return (1" 1/4 GAS)
8. Cold side water supply (1" 1/4 GAS)
9. Functional spaces
10. Vibration damper mounts $\varnothing 12,5$
11. Partial recovery water return (1" 1/4 Victaulic)
12. Partial recovery water supply (1" 1/4 Victaulic)

SIZE		12.2	16.2	19.2	22.2
Length	mm	837	837	837	837
Height	mm	1483	1483	1483	1483
Depth	mm	607	607	607	607
Operating weight - OTH4	kg	212	276	295	308
Shipping weight OTH4	kg	206	263	277	295
Operating weight - OTL4	kg	218	287	302	315
Shipping weight OTL4	kg	210	270	282	300

The presence of optional accessories may result in a substantial variation of the weights shown in the table.

Dimensional drawings

OTH4 version without hydronic unit

Size 27.2 - 55.2

DAA8P27_2_60 2 STD REV01

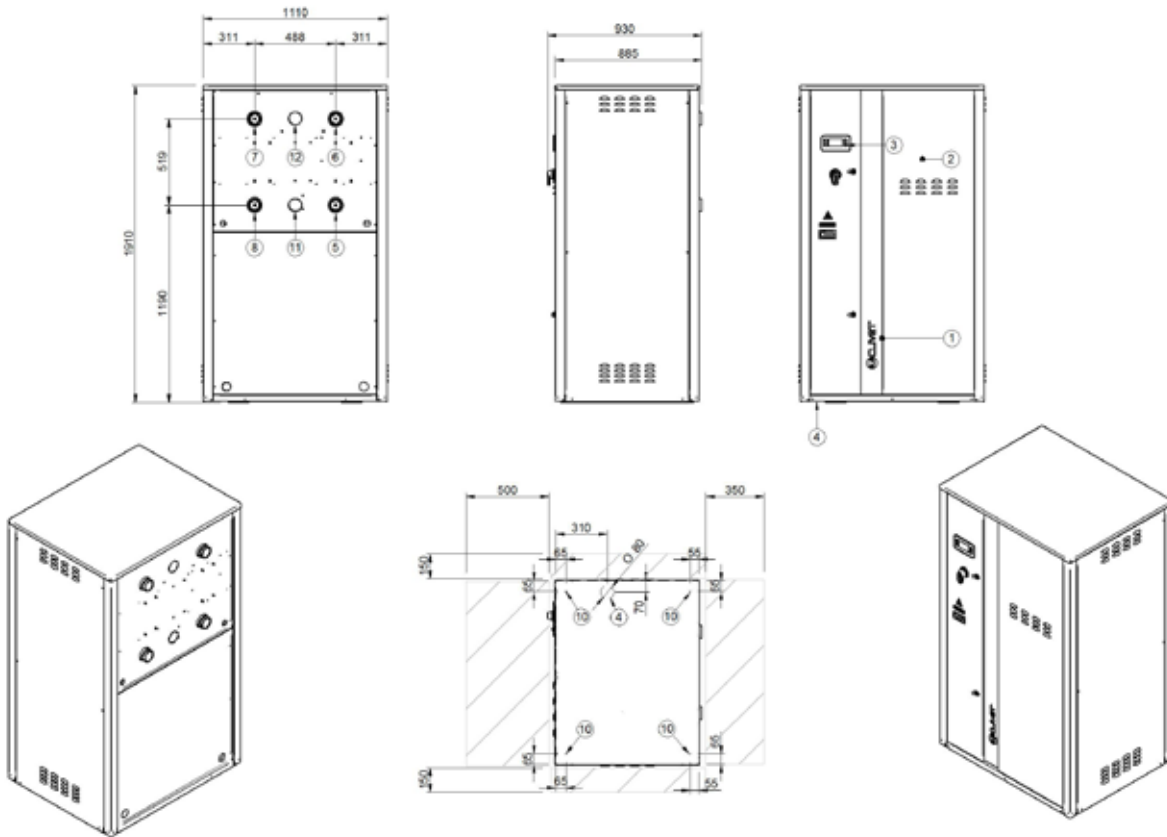

1. Compressor compartment
2. Electrical panel
3. Unit control keypad
4. Power input
5. Hot side water return (2" 1/2 Victaulic)
6. Hot side water supply (2" 1/2 Victaulic)
7. Cold side water return (2" 1/2 Victaulic)
8. Cold side water supply (2" 1/2 Victaulic)
9. Functional spaces
10. Vibration damper mounts Ø 12,5
11. Partial recovery water return (2" Victaulic)
12. Partial recovery water supply (2" Victaulic)

SIZE		27.2	35.2	40.2	45.2	55.2	60.2
Length	mm	1110	1110	1110	1110	1110	1110
Height	mm	1910	1910	1910	1910	1910	1910
Depth	mm	885	885	885	885	885	885
Operating weight - OTH4	kg	421	510	557	572	700	733
Shipping weight OTH4	kg	418	505	548	560	683	717

The presence of optional accessories may result in a substantial variation of the weights shown in the table.

OTH4 version without hydronic unit

Size 70.2 - 80.2

DAA8P70 2_90 2 STD REV00

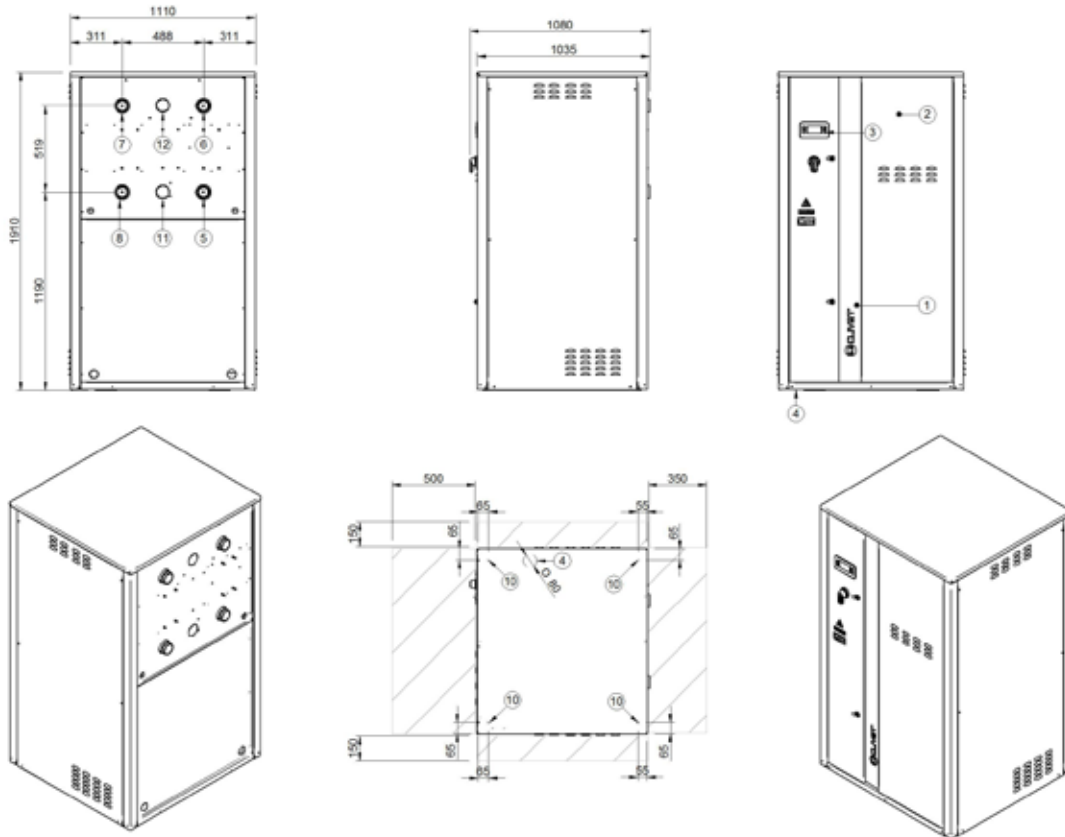

1. Compressor compartment
2. Electrical panel
3. Unit control keypad
4. Power input
5. Hot side water return (2" 1/2 Victaulic)
6. Hot side water supply (2" 1/2 Victaulic)
7. Cold side water return (2" 1/2 Victaulic)
8. Cold side water supply (2" 1/2 Victaulic)
9. Functional spaces
10. Vibration damper mounts $\varnothing 12,5$
11. Partial recovery water return (2" Victaulic)
12. Partial recovery water supply (2" Victaulic)

SIZE		70.2	80.2
Length	mm	1110	1110
Height	mm	1910	1910
Depth	mm	1035	1035
Operating weight - OTH4	kg	771	809
Shipping weight OTH4	kg	749	781

The presence of optional accessories may result in a substantial variation of the weights shown in the table.

Dimensional drawings

OTL4 version without hydronic unit

Size 27.2 - 45.2

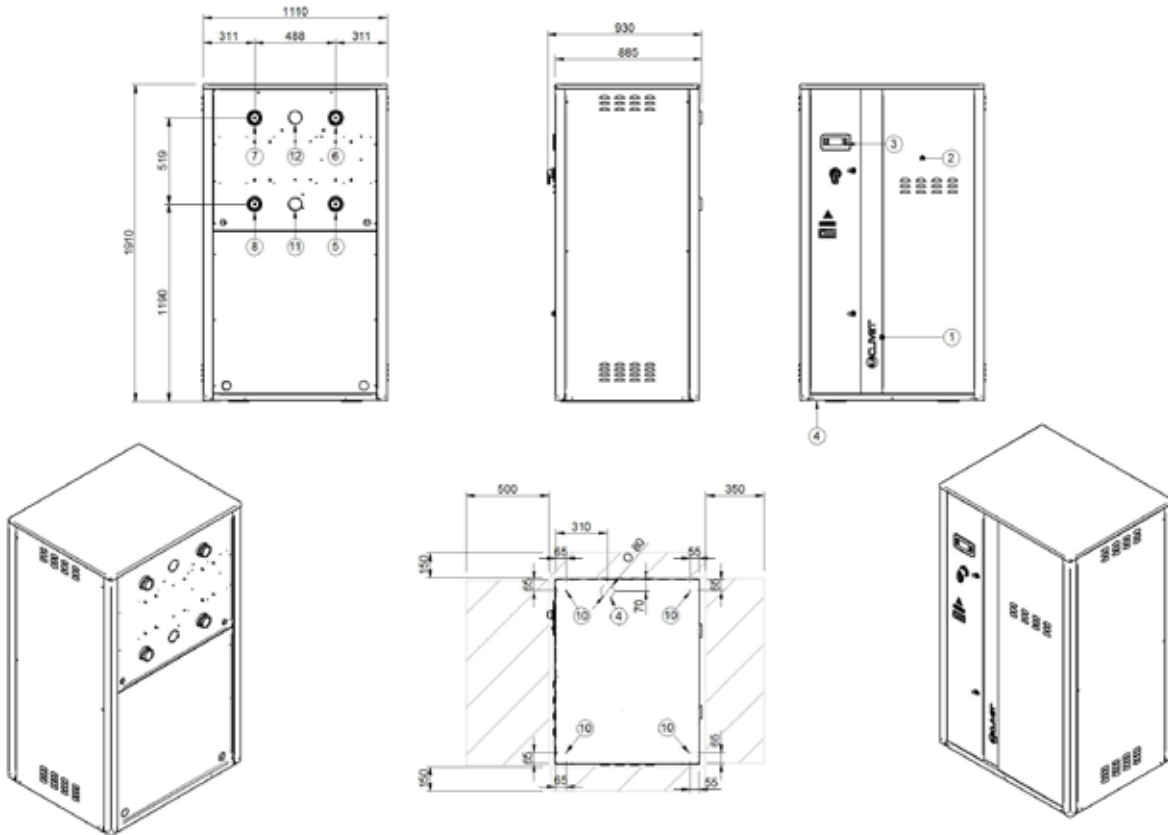

- 1) Compressor compartment
- 2) Electrical panel
- 3) Unit control keypad
- 4) Power input
- 5) Hot side water return (2" 1/2 Victaulic)
- 6) Hot side water supply (2" 1/2 Victaulic)
- 7) Cold side water return (2" 1/2 Victaulic)
- 8) Cold side water supply (2" 1/2 Victaulic)
- 9) Functional spaces
- 10) Vibration damper mounts \varnothing 12,5
- 11) Partial recovery water return (2" Victaulic)
- 12) Partial recovery water supply (2" Victaulic)

SIZE		27.2	35.2	40.2	45.2
Length	mm	1110	1110	1110	1110
Height	mm	1910	1910	1910	1910
Depth	mm	885	885	885	885
Operating weight - OTL4	kg	452	529	594	607
Shipping weight OTL4	kg	442	520	576	587

The presence of optional accessories may result in a substantial variation of the weights shown in the table.

OTL4 version without hydronic unit

Size 55.2 - 80.2

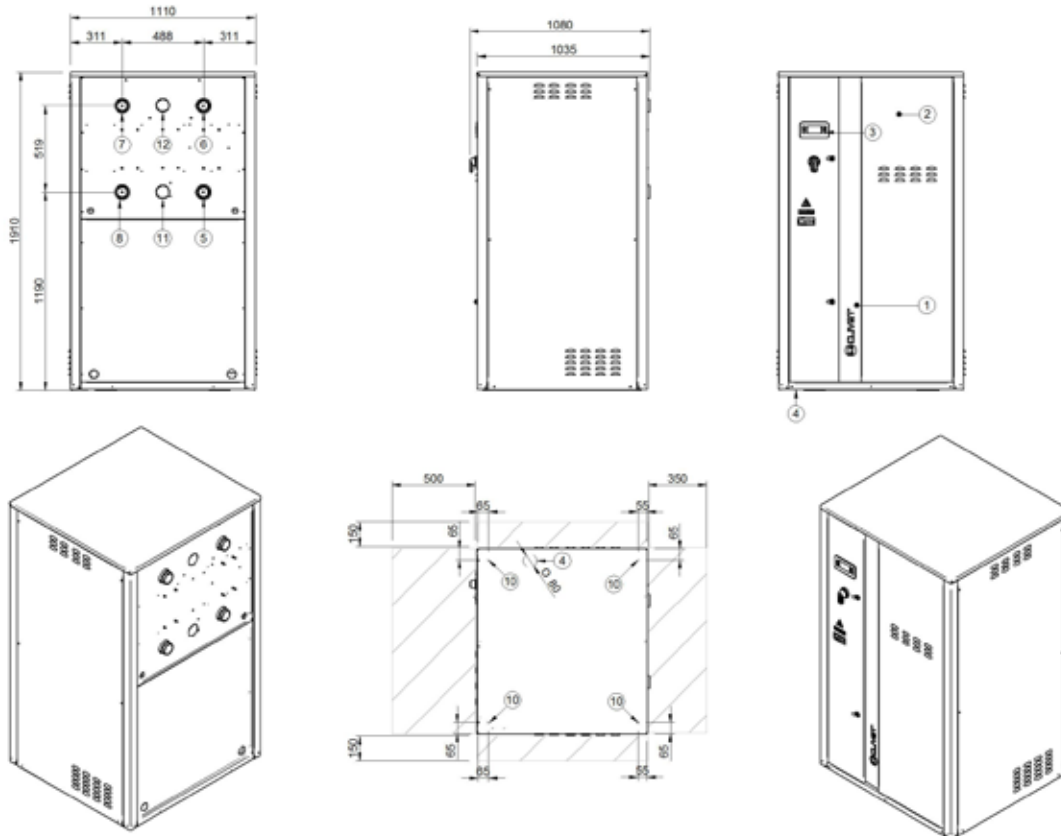

- 1) Compressor compartment
- 2) Electrical panel
- 3) Unit control keypad
- 4) Power input
- 5) Hot side water return (2" 1/2 Victaulic)
- 6) Hot side water supply(2" 1/2 Victaulic)
- 7) Cold side water return (2" 1/2 Victaulic)
- 8) Cold side water supply (2" 1/2 Victaulic)
- 9) Functional spaces
- 10) Vibration damper mounts \varnothing 12,5
- 11) Partial recovery water return (2" Victaulic)
- 12) Partial recovery water supply (2" Victaulic)

SIZE		55.2	60.2	70.2	80.2
Length	mm	1110	1110	1110	1110
Height	mm	1910	1910	1910	1910
Depth	mm	885	885	885	885
Operating weight - OTL4	kg	757	772	829	841
Shipping weight OTL4	kg	728	748	794	806

The presence of optional accessories may result in a substantial variation of the weights shown in the table.

Dimensional drawings

OTH4 and OTL4 version without hydronic unit

Size 100.2 - 120.2

DAA8P100 2_120 2 STD REV00

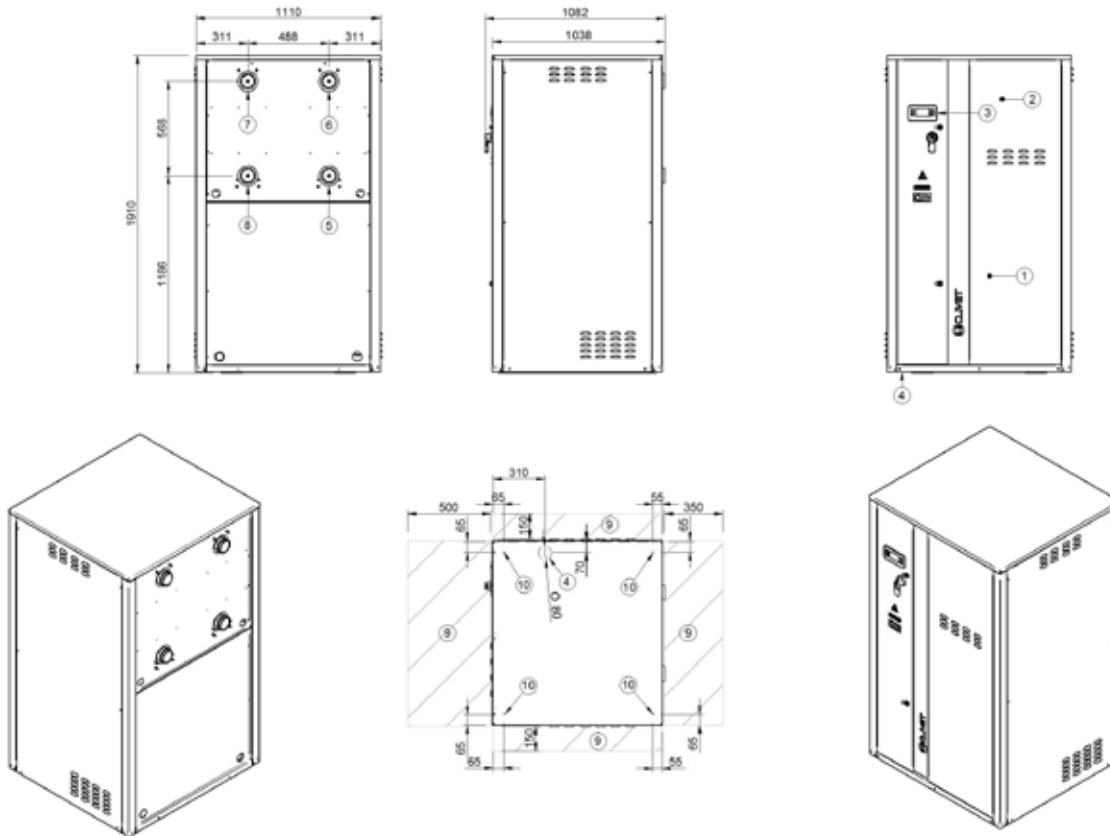

1. Compressor compartment
2. Electrical panel
3. Unit control keypad
4. Power input
5. Hot side water return (3" Victaulic)
6. Hot side water supply (3" Victaulic)
7. Cold side water return (3" Victaulic)
8. Cold side water supply (3" Victaulic)
9. Functional spaces
10. Vibration damper mounts \varnothing 12,5

SIZE		100.2	120.2
Length	mm	1110	1110
Height	mm	1910	1910
Depth	mm	1038	1038
Operating weight - OTH4	kg	1085	1205
Shipping weight OTH4	kg	1017	1131
Operating weight - OTL4	kg	1129	1271
Shipping weight OTL4	kg	1050	1182

The presence of optional accessories may result in a substantial variation of the weights shown in the table.

OTH4 and OTL4 version with hydronic unit option and oversize enclosure (MOBMAG)

Size 12.2 - 22.2

DAA8P10 2_22 2 MAG REV00

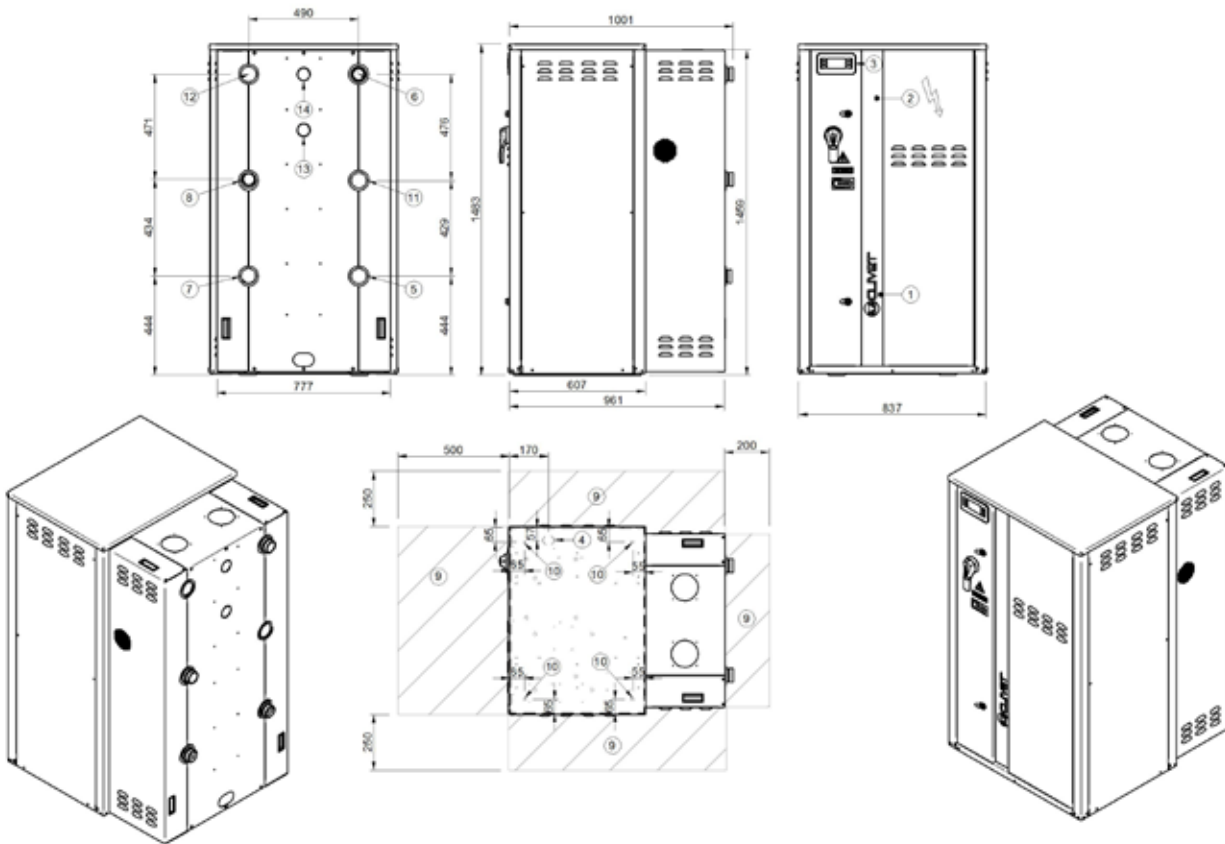

1. Compressor compartment
2. Electrical panel
3. Unit control keypad
4. Power input
5. Hot side water return (2" Victaulic)
6. Hot side water supply (2" Victaulic)
7. Cold side water return (2" Victaulic)
8. Cold side water supply (2" Victaulic)
9. Functional spaces
10. Vibration damper mounts \varnothing 12,5
11. Hot side water return without pumps (2" Victaulic)
12. Cold side water return without pumps (2" Victaulic)
13. Partial recovery water return (1" 1/4 Victaulic)
14. Partial recovery water supply (1" 1/4 Victaulic)

SIZE		12.2	16.2	19.2	22.2
Length	mm	837	837	837	837
Height	mm	1483	1483	1483	1483
Depth	mm	961	961	961	961
Operating weight - OTH4	kg	285	352	372	385
Shipping weight OTH4	kg	268	328	342	360
Operating weight - OTL4	kg	292	363	379	392
Shipping weight OTL4	kg	272	335	347	365

The weights refer to the unit equipped with the following options: cold side hydronic unit VARYFLOW+ (VARYC), hot side hydronic unit VARYFLOW+ (VARYH), oversize enclosure (MOBMAG). The presence of optional accessories may result in a substantial variation of the weights shown in the table.

Dimensional drawings

OTH4 Version with hydronic unit option and oversize enclosure (MOBMAG)

Size 27.2 - 60.2

DAA8P27 2_60 2 MAG REV01

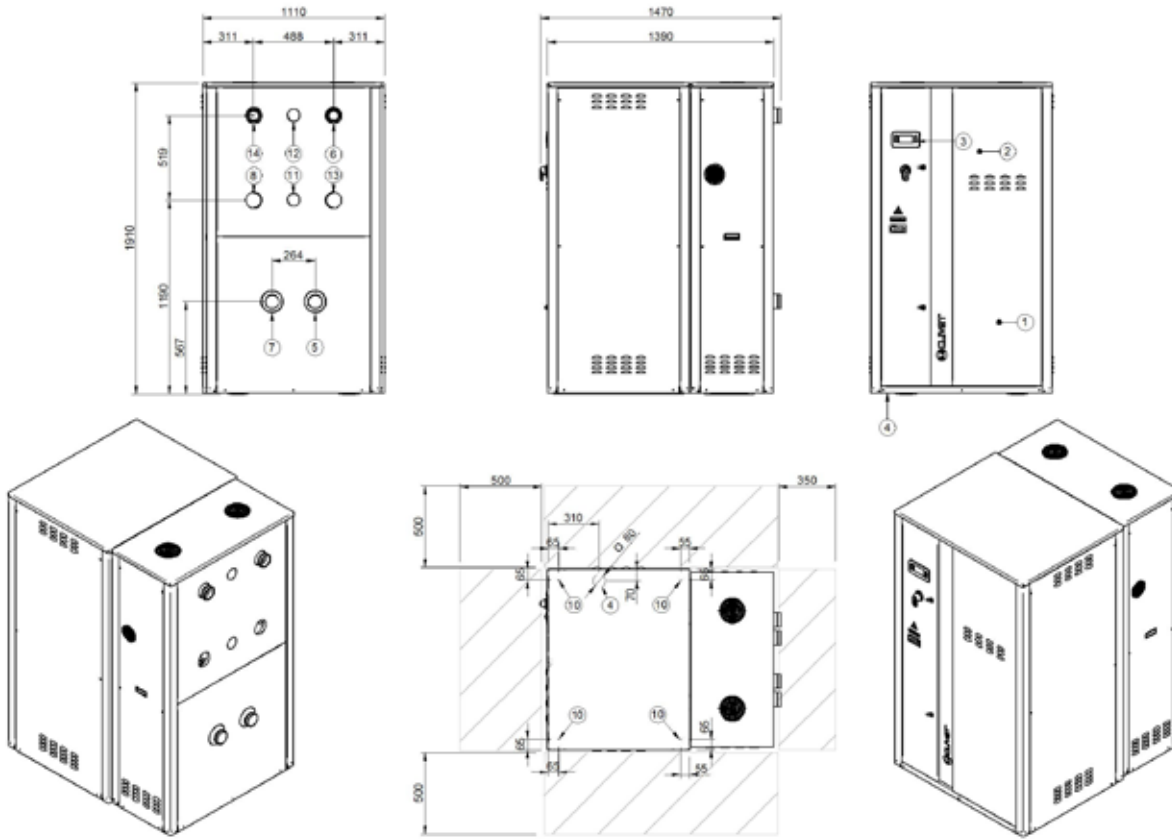

1. Compressor compartment
2. Electrical panel
3. Unit control keypad
4. Power input
5. Hot side water return (3" Victaulic)
6. Hot side water supply (3" Victaulic)
7. Cold side water return (3" Victaulic)
8. Cold side water supply (3" Victaulic)
9. Functional spaces
10. Vibration damper mounts $\varnothing 12,5$
11. Partial recovery water return (2" Victaulic)
12. Partial recovery water supply (2" Victaulic)
13. Hot side water return without pumps (3" Victaulic)
14. Cold side water return without pumps (3" Victaulic)

SIZE		27.2	35.2	40.2	45.2	55.2	60.2
Length	mm	1110	1110	1110	1110	1110	1110
Height	mm	1910	1910	1910	1910	1910	1910
Depth	mm	1390	1390	1390	1390	1390	1390
Operating weight - OTH4	kg	567	656	710	743	878	911
Shipping weight OTH4	kg	534	621	672	685	816	850

The weights refer to the unit equipped with the following options: cold side hydronic unit VARYFLOW+ (VARYC), hot side hydronic unit VARYFLOW+ (VARYH), oversize enclosure (MOBMAG)

The presence of optional accessories may result in a substantial variation of the weights shown in the table.

OTH4 Version with hydronic unit option and oversized enclosure (MOBMAG)

Size 70.2 - 80.2

DAA8P70_2_90 2 MAG REV00

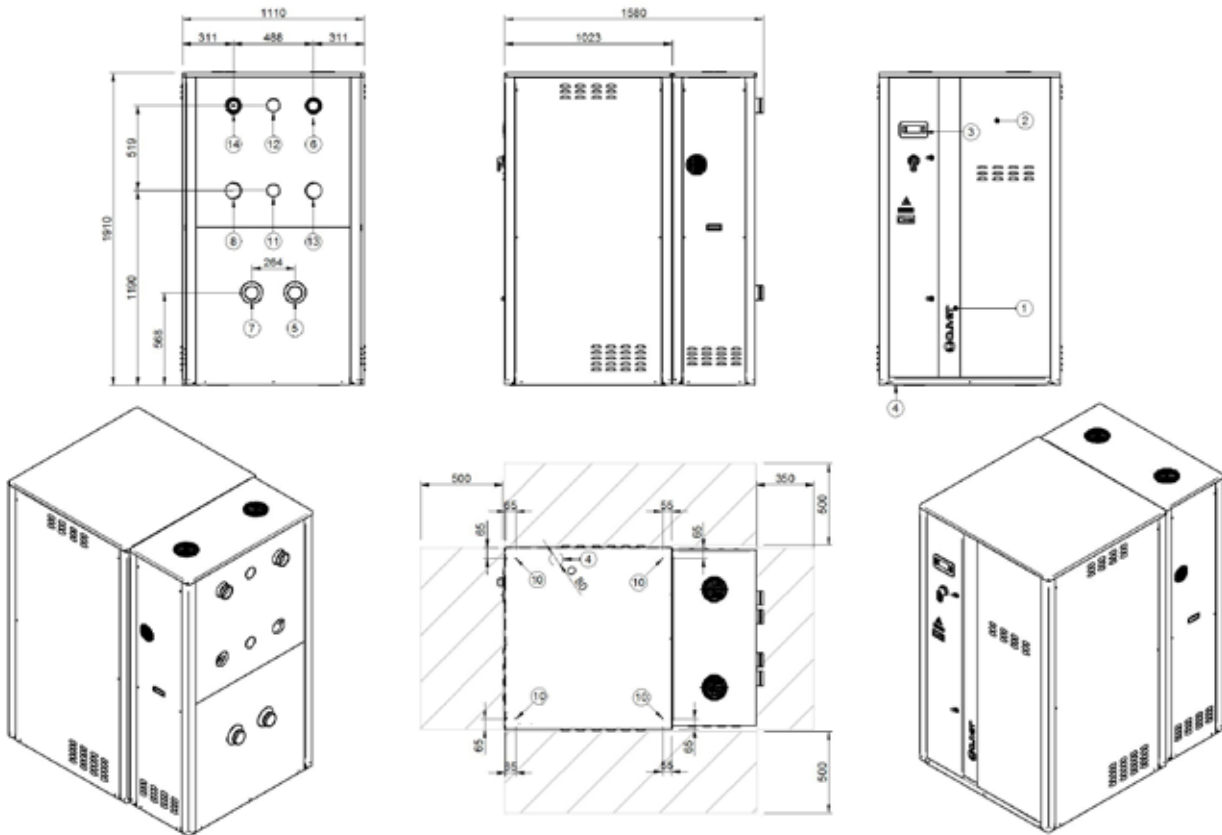

1. Compressor compartment
2. Electrical panel
3. Unit control keypad
4. Power input
5. Hot side water return (3" Victaulic)
6. Hot side water supply (3" Victaulic)
7. Cold side water return (3" Victaulic)
8. Cold side water supply (3" Victaulic)
9. Functional spaces
10. Vibration damper mounts $\varnothing 12,5$
11. Partial recovery water return (2" Victaulic)
12. Partial recovery water supply (2" Victaulic)
13. Hot side water return without pumps (3" Victaulic)
14. Cold side water return without pumps (3" Victaulic)

SIZE		70.2	80.2
Length	mm	1110	1110
Height	mm	1910	1910
Depth	mm	1580	1580
Operating weight - OTH4	kg	956	993
Shipping weight OTH4	kg	888	920

The weights refer to the unit equipped with the following options: cold side hydronic unit VARYFLOW+ (VARYC), hot side hydronic unit VARYFLOW+ (VARYH), oversized enclosure (MOBMAG)

The presence of optional accessories may result in a substantial variation of the weights shown in the table.

OTL4 version with hydronic unit option and oversize enclosure (MOBMAG)

Size 55.2 - 80.2

DAA8P55 2_90 2 MAG_GEO REV00

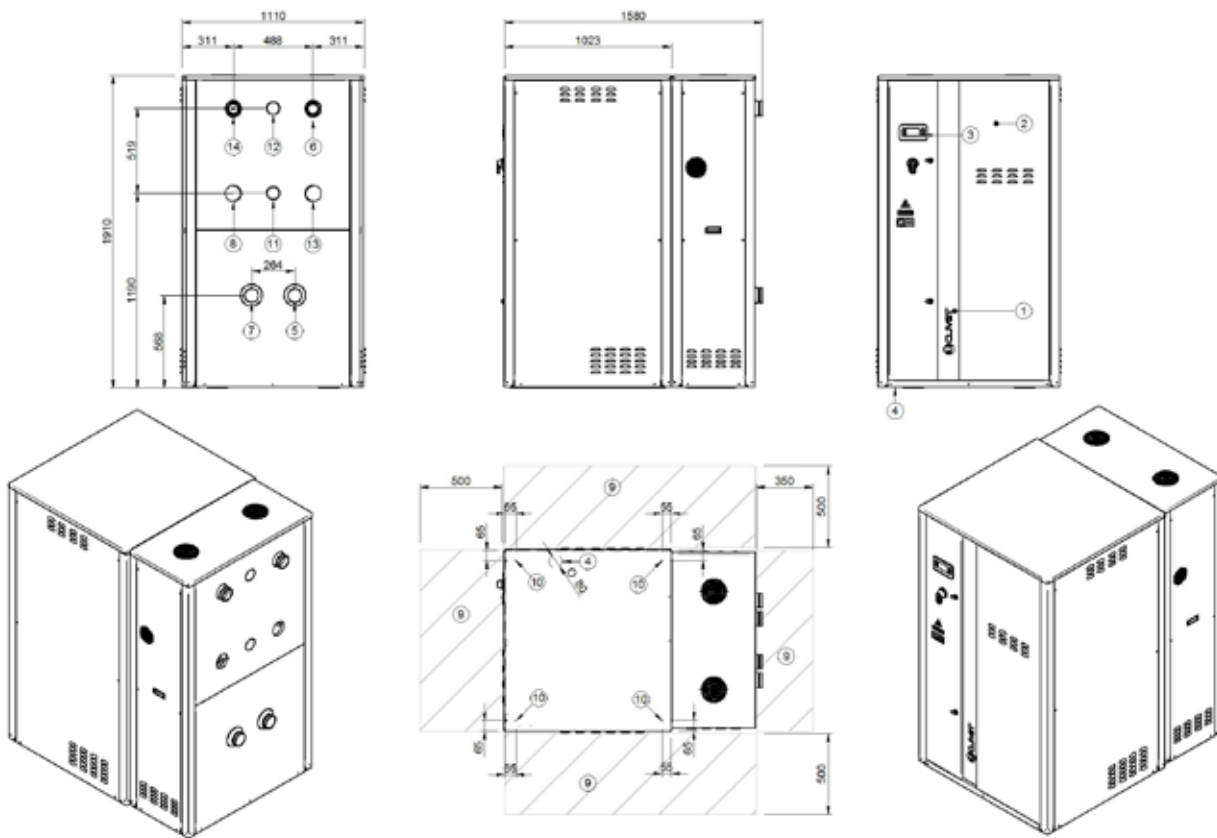

1. Compressor compartment
2. Electrical panel
3. Unit control keypad
4. Power input
5. Hot side water return (3" Victaulic)
6. Hot side water supply (3" Victaulic)
7. Cold side water return (3" Victaulic)
8. Cold side water supply (3" Victaulic)
9. Functional spaces
10. Vibration damper mounts \varnothing 12,5
11. Partial recovery water return (2" Victaulic)
12. Partial recovery water supply (2" Victaulic)
13. Hot side water return without pumps (3" Victaulic)
14. Cold side water return without pumps (3" Victaulic)

SIZE		55.2	60.2	70.2	80.2
Length	mm	1110	1110	1110	1110
Height	mm	1910	1910	1910	1910
Depth	mm	1580	1580	1580	1580
Operating weight - OTL4	kg	935	950	1013	1025
Shipping weight OTL4	kg	861	881	933	945

The weights refer to the unit equipped with the following options: cold side hydronic unit VARYFLOW+ (VARYC), hot side hydronic unit VARYFLOW+ (VARYH), oversize enclosure (MOBMAG)

The presence of optional accessories may result in a substantial variation of the weights shown in the table.

Pagina intenzionalmente bianca

Pagina intenzionalmente bianca

FOR OVER 30 YEARS WE HAVE BEEN
OFFERING SOLUTIONS TO ENSURE
SUSTAINABLE COMFORT AND THE WELL-
BEING OF PEOPLE AND THE ENVIRONMENT

www.clivet.com

MideaGroup
Humanizing Technology

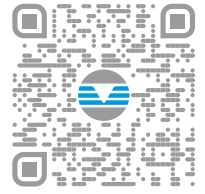

sale and assistance



CLIVET S.p.A.

Via Camp Lonc 25, Z.I. Villapaiera 32032 - Feltre (BL) - Italy
Tel. +39 0439 3131 - info@clivet.it

CLIVET GMBH

Hummelsbütteler Steindamm 84,
22851 Norderstedt, Germany
Tel. +49 40 325957-0 - info.de@clivet.com

Clivet Group UK LTD

Units F5 & F6 Railway Triangle,
Portsmouth, Hampshire PO6 1TG
Tel. +44 02392 381235 -
Enquiries@Clivetgroup.co.uk

CLIVET LLC

Office 508-511, Elektrozavodskaya st. 24,
Moscow, Russian Federation, 107023
Tel. +7495 6462009 - info.ru@clivet.com

CLIVET MIDEAST FZCO

Dubai Silicon Oasis (DSO) Headquarter Building,
Office EG-05, P.O Box-342009, Dubai, UAE
Tel. +9714 3208499 - info@clivet.ae

Clivet South East Europe

Jarušćica 9b
10000, Zagreb, Croatia
Tel. +3851 222 8784 - info.see@clivet.com

CLIVET France

10, rue du Fort de Saint Cyr - 78180 Montigny le
Bretonneux, France
info.fr@clivet.com

Clivet Airconditioning Systems Pvt Ltd

Office No.501 & 502,5th Floor, Commercial -I,
Kohinoor City, Old Premier Compound, Off LBS
Marg, Kiroi Road, Kurla West, Mumbai
Maharashtra 400070, India
Tel. +91 22 30930200 - sales.india@clivet.com

ELFOEnergy Ground Medium - WSH-XEE2 - BT20G552GB-02